

# Hazel Classic Universal Sling



## User Manual

<b>1</b>	<b>Introduction</b>	<b>3</b>
1.1	Intended Use	3
1.2	Manufacture	3
1.3	European Authorised Representative	3
1.4	Symbols Used	4
1.5	Contraindications / Limitations	5
1.6	Sling Compatibility	5
1.7	Safety Instructions and Warnings	5
<b>2</b>	<b>Components/Key Parts</b>	<b>7</b>
2.1	Sling Options	8
2.2	Material Options	10
<b>3</b>	<b>User Instructions</b>	<b>11</b>
3.1	How to fit from a seated position	11
3.2	How to Fit from a lying position	12
3.3	Attaching loop fixing to Carry Bar	12
<b>4</b>	<b>Technical Specification</b>	<b>13</b>
4.1	Sling Dimensions	13
<b>5</b>	<b>Environmental Conditions</b>	<b>14</b>
5.1	Operating Environment	14
5.1.1	Normal Operating Conditions	14
5.2	Storage Conditions	14
5.2.1	Shipping and Storage Conditions	14
5.3	Standards Applied	14
<b>6</b>	<b>Daily Checks</b>	<b>15</b>
<b>7</b>	<b>Cleaning</b>	<b>16</b>
7.1	Washing guidelines	16
7.2	Drying Guidelines	16
<b>8</b>	<b>Servicing</b>	<b>17</b>
<b>9</b>	<b>Disposal</b>	<b>17</b>
<b>10</b>	<b>Warranty</b>	<b>18</b>
<b>11</b>	<b>Inspection Record History</b>	<b>19</b>

## 1 Introduction

This manual provides comprehensive information about the Oak Universal Sling, including details about all available options.



Please read and understand this manual in its entirety before using your Mackworth Sling. The information in this manual is important for the safety of anyone using the sling and must be read and understood to help prevent injuries. It is also crucial to the proper operation and maintenance of the sling.

This user manual should be kept safe for future reference. Contents of this manual are subject to change without prior written notice.

Should any questions arise from reviewing this manual, contact your local authorised representative.

If, during the use of this device or because of its use, a serious incident has occurred please report it to the manufacturer and to your national authority.

### 1.1 Intended Use

The sling is a piece of equipment used for moving and handling patients, which works in conjunction with a mechanical lift. It's a fabric-made item that goes under and around the patient and attaches to a lift carry bar, enabling the safe and secure transfer of the patient from one location to another.

A risk assessment must be performed before using the sling to ensure safe use can be established. You may need to seek specialist advice on how to assist some people with specific moving and handling needs. Sources of advice include, but are not limited to, professional bodies and organisations, occupational therapists, physiotherapists, manual handling advisers and ergonomists with experience in health and social care.

The manufacturer always recommends training before use of our products. For more details on the training that can be provided please contact your local authorised dealer.

### 1.2 Manufacture

The sling is manufactured at the address below:



**Prism Medical UK**

Millers Avenue, Brynmenyn Industrial Estate, Brynmenyn, Bridgend, CF32 9TD  
Telephone number: +44 (0)800 779 7218

### 1.3 European Authorised Representative

The address of the European Authorised Representative for this product:



European Healthcare & Device Solutions (Ireland) Ltd.  
Stratton House, Bishopstown Road,  
Cork, Ireland.  
T12 Y9TC.  
Telephone number: +353(86)2280846

## 1.4 Symbols Used

The Table below includes all symbols from BS EN ISO 15223-1:2021 that can be found in this manual and on the Product and what they represent. Refer to this Table when you are unsure of what a symbol represents.



















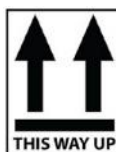

			
Place of Manufacture	Country of Manufacture	Serial number	Catalogue number
			<b>SWL</b>
Caution – see instructions for use	Consult instructions for use	UK Conformity Assessed	Safe Working Load
			
For internal use only	Packaging indicator – Keep dry	Do not use if package is damaged	Packaging indicator – This way up
			
Fragile, handle with care	Please observe local laws on recycling	Non-sterile	Atmospheric pressure limitation
		Degree of protection <b>IP<sub>N<sub>1</sub></sub>N<sub>2</sub></b>	
Temperature range	Humidity range	provided by enclosure. N <sub>1</sub> : Ingress of particles N <sub>2</sub> : Ingress of water	Medical Device
			
European Authorised Representative	Machine wash hot	Do not bleach	Do not Iron
			
Tumble Dry Low Heat	Loop style attachment for sling	Clip Style attachment for sling	Type 'B' applied part.

Table 1-1

### **1.5 Contraindications / Limitations**

There are no known "contraindications" associated with the usage of the sling, provided it is used as per the manufacturer's recommendations and guidelines. However, it is recommended that a client specific assessment is completed by a trained and knowledgeable health care professional to determine the method of transfer and use.

The manufacturer does not recommend a required number of operators for the use of our products. This information and recommendation can only be provided after a thorough personalised, case specific assessment, as there are many factors that can influence these decisions.

Limitations of the sling include:

- The sling should only be used by individuals who are competent and have received appropriate training on its use.
- The sling should only be used with users weighing under the safe working load of the sling.
- The sling is only to be used within the environment it is intended for. Slings must only be relocated by an authorised person.
- The slings are designed for human transfer/use only. There is no other application to this product.
- The caregiver must always pay attention to the well-being of the user when utilizing the sling. Users should not be left unsupervised during use.

### **1.6 Sling Compatibility**

Sling Sizes and coding often varies greatly between manufacturers. However, there is no evidence to suggest that slings and mechanical lifts can't be "appropriately matched" with other manufacturer's designs. That is providing that the loop applications are applied relevant to the male fitting and a thorough risk assessment is conducted by the clinician / carer beforehand. Ensure you are aware of the mechanical lift manufacturer's fitting instructions and identify if the lift requires a loop fitting.

### **1.7 Safety Instructions and Warnings**

Ensure to read and understand all the statements below, for the safety of the caregivers and users, along with warranty requirements. Failure to comply with warnings in this manual may result in; injury to the operator and/or client and/or damage to the lift or related components.

- Do not attempt to use this equipment without first understanding the contents of this manual.
- If you are unsure on the correct use of this product, please contact the manufacturer or a professional for further information or training.
- The sling is intended to be used on a flat or levelled surface when used in conjunction with a mobile Lift.
- Under no circumstance should the sling be put in control of a person who has not been properly trained in the use and care of this equipment. Failure to adhere to this warning may result in serious injury to the operator and/or the individual.
- In facilities where more than one operator will be responsible for using the sling, it is imperative that all such members be trained on the sling prior to use. A training program should be established by the facility to acquaint new operators with this equipment.
- Your guarantee is void if persons unauthorised by Mackworth perform work or modification to the sling.

- To maintain optimum function and safety, the sling should be inspected and maintained on a regular basis. See section 'Daily Checks, and Cleaning' within this user manual.
- In areas where children are likely to be present, be vigilant when using the sling.
- Any accessories used with the sling, such as a Lift, should be checked to ensure that they are in good working order. Check for signs of wear to each component prior to use. Report any unusual wear to your local authorized dealer.
- Do not exceed the maximum rated load of the sling.
- Ensure that a clear space is maintained around the sling before performing a transfer, check for and move all obstacles out of the way.
- Protecting the people present, when using the sling with a medical Lift, visually monitor the looped connection points during transfer stages, so the sling remains firmly attached to the connection hooks.
- To reduce the risk of unintended use, when the sling is not in use remove the sling from any medical lift to prevent entrapment or strangulation should the device be tampered with.
- Between the sling and any medical lift, the lowest maximum load shall always be used.

## 2 Components/Key Parts

Please see below to familiarise yourself with the components of the sling. If you have not received all the components listed below, contact your local dealer immediately – contact details are provided on the last page of this manual.

Item	Description
1.	Sling Body – Patient sits here
2.	Optional Head Support
3.	Shoulder Lift Straps
4.	Quilted Leg Sections
5.	Leg Lifting Straps
6.	Embroidered SWL and Serial Number Label.
7.	Sling Information Label
8.	User Manual

Table 2-1

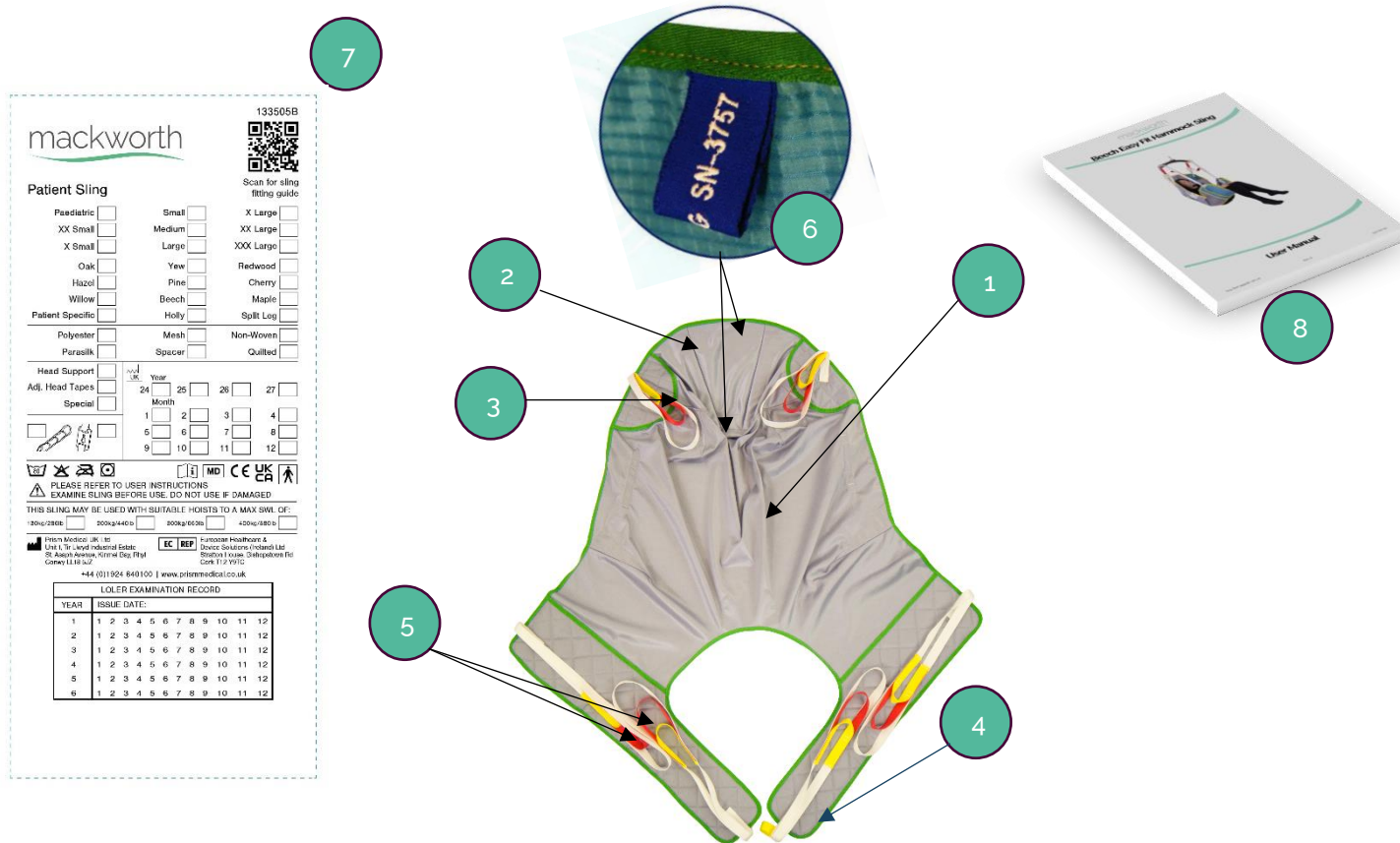

Fig. 2-1

## 2.1 Sling Options

Below is list of available slings, complete with information regarding the material offered.

Sling Options				
Without a Head Support	Sling Size	Material	Carry Bar Attachment	Part Code
	Small	Polyester Solid	Loop	1201HZ7500
	Small	Polyester Mesh	Loop	1201HZ8500
	Small	Parasilk	Loop	1201HZ3500
	Small	Quilted	Loop	1201HZ5500
	Small	Supersoft Spacer	Loop	1201HZ4500
	Medium	Polyester Solid	Loop	1201HZ7400
	Medium	Polyester Mesh	Loop	1201HZ8400
	Medium	Parasilk	Loop	1201HZ3400
	Medium	Quilted	Loop	1201HZ5400
	Medium	Supersoft Spacer	Loop	1201HZ4400
	Large	Polyester Solid	Loop	1201HZ7300
	Large	Polyester Mesh	Loop	1201HZ8300
	Large	Parasilk	Loop	1201HZ3300
	Large	Quilted	Loop	1201HZ5300
	Large	Supersoft Spacer	Loop	1201HZ4200
	X-Large	Polyester Solid	Loop	1201HZ7200
	X-Large	Polyester Mesh	Loop	1201HZ8200
	X-Large	Parasilk	Loop	1201HZ3200
	X-Large	Quilted	Loop	1201HZ5200
	X-Large	Supersoft Spacer	Loop	1201HZ4200
	XX-Large	Polyester Solid	Loop	1201HZ7100
	XX-Large	Polyester Mesh	Loop	1201HZ8100
	XX-Large	Parasilk	Loop	1201HZ3100
XX-Large	Quilted	Loop	1201HZ5100	
XX-Large	Supersoft Spacer	Loop	1201HZ4100	
XXX-Large	Polyester Solid	Loop	1201HZ7000	
XXX-Large	Polyester Mesh	Loop	1201HZ8000	
XXX-Large	Parasilk	Loop	1201HZ3000	
XXX-Large	Quilted	Loop	1201HZ5000	
XXX-Large	Supersoft Spacer	Loop	1201HZ4000	

Table 2.1-1

Continues.....



Sling Options				
With a Head Support	Sling Size	Material	Carry Bar Attachment	Part Code
	Small	Polyester Solid	Loop	1201HZ7520
	Small	Polyester Mesh	Loop	1201HZ8520
	Small	Parasilk	Loop	1201HZ3520
	Small	Quilted	Loop	1201HZ5520
	Small	Supersoft Spacer	Loop	1201HZ4520
	Medium	Polyester Solid	Loop	1201HZ7420
	Medium	Polyester Mesh	Loop	1201HZ8420
	Medium	Parasilk	Loop	1201HZ3420
	Medium	Quilted	Loop	1201HZ5420
	Medium	Supersoft Spacer	Loop	1201HZ4420
	Large	Polyester Solid	Loop	1201HZ7320
	Large	Polyester Mesh	Loop	1201HZ8320
	Large	Parasilk	Loop	1201HZ3320
	Large	Quilted	Loop	1201HZ5320
	Large	Supersoft Spacer	Loop	1201HZ4220
	X-Large	Polyester Solid	Loop	1201HZ7220
	X-Large	Polyester Mesh	Loop	1201HZ8220
	X-Large	Parasilk	Loop	1201HZ3220
	X-Large	Quilted	Loop	1201HZ5220
	X-Large	Supersoft Spacer	Loop	1201HZ4220
	XX-Large	Polyester Solid	Loop	1201HZ7120
	XX-Large	Polyester Mesh	Loop	1201HZ8120
	XX-Large	Parasilk	Loop	1201HZ3120
XXX-Large	Polyester Solid	Loop	1201HZ7020	
XXX-Large	Polyester Mesh	Loop	1201HZ8020	
XXX-Large	Parasilk	Loop	1201HZ3020	
XXX-Large	Quilted	Loop	1201HZ5020	
XXX-Large	Supersoft Spacer	Loop	1201HZ4020	

Table 2.1-2

**Additional options are available upon request. Please contact your local Dealer for more information.**

## 2.2 Material Options



*Polyester Solid*



*Polyester Mesh*

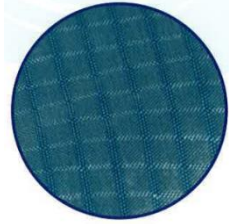

*Parasilk*



*Quilted*



*Supersoft Spacer*

Material	Benefits
Polyester Solid	The material is quick to dry and can be submerged in water along with being extremely tough, lightweight, and flexible, reducing shock while loading.
Polyester Mesh	The mesh version of the polyester material adds an additional benefit of assisting in body temperature regulation and provides some breathability. As with the solid polyester material is quick to dry and can be submerged in water along with being extremely tough, lightweight, and flexible, reducing shock while loading.
Parasilk	Parasilk fabric is a fine and soft material, allowing the sling to slide smoothly under the patient. This soft fabric also prevents pressure areas, making it suitable for patients with sensitive skin conditions.
Quilted	A padded and quilted polyester fabric which enhances patient comfort.
Supersoft Spacer	A "supersoft" breathable, stretch capable fabric, which is also padded for comfort during longer periods of transfer and reducing the risk of skin conditions.

### 3 User Instructions



Prior to use: - Ensure you are aware of the Lift manufacturer's fitting instructions.

- a. Inspect the sling for wear and damage, with particular attention being paid to the body of the sling, webbings, and stitch lines.
- b. If the sling is fitted with a head support, ensure the 2 head stays are fitted in the head pockets.
- c. If following inspection, there is any doubt, (points 1-2) the sling should be placed aside and not used, then reported.

The section below gives detailed instructions on how to fit and remove the sling. These instructions must be adhered to for a successful and safe use of the sling. If you are unsure of any processes, always seek advice.

#### 3.1 How to fit from a seated position

- a. Place the sling behind the patient ensuring that all handles and labels are on the outside and visible. Feed the sling down the back of the patient. This should be at the base of the spine and positioned centrally to the patient's back. The sling should now lie square across the patient's shoulders.

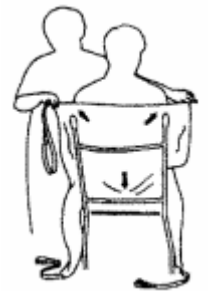

- b. Raise each leg individually and gradually feed the leg straps under each leg, ensuring no fabric twists are evident. Thread the short inner leg loop through the modesty loop (small yellow loop) on the other leg. By carrying out this arrangement, you are ensuring comfort for the patient during the lifting process. The front of the sling legs should be about 2 inches behind the knee. If you find that you cannot achieve these positions, then a different size sling may need to be considered.



- c. With the sling now in place, attach the desired loops to the hooks on the spreader bar to replicate the sitting position that the patient is in whilst seated, the straps should be positioned accordingly, subsequently the tension on all four straps should take at the same time.



- d. **Make sure that the colour loops selected are the same on each side of the sling and ensure that they are still securely attached before lifting the patient.** The person can now be lifted as required. To remove the sling, carry out the fitting procedure in reverse. Important – always peel the sling away from the person – this avoids skin friction.



## 3.2 How to Fit from a lying position.

- a. Using good manual handling techniques roll the person towards you so that they are positioned on their side. To introduce the sling, roll half of the sling up under itself so that when the person is rolled onto their opposite side, the sling can be unrolled until it is flat. Use the centre pocket to ensure the base of the back section is in line with base of the person's spine. Ensure that handle loops are to the outside.
- b. Raise each leg individually and gradually feed the leg straps under each leg, ensuring no fabric twists are evident. Thread the lower leg webbing through the modesty loop (small yellow loop) on the other leg. By carrying out this arrangement, you are ensuring comfort for the patient during the lifting process; the four straps should now be attached to the spreader bar hooks. Raise the carry bar just enough so that all the straps are under a slight tension.
- c. **Make sure that the colour loops selected are the same on each side of the sling and ensure that they are still securely attached before lifting the patient.** The person can now be lifted as required. To remove the sling, carry out the fitting procedure in reverse. Important – always peel the sling away from the person – this avoids skin friction.

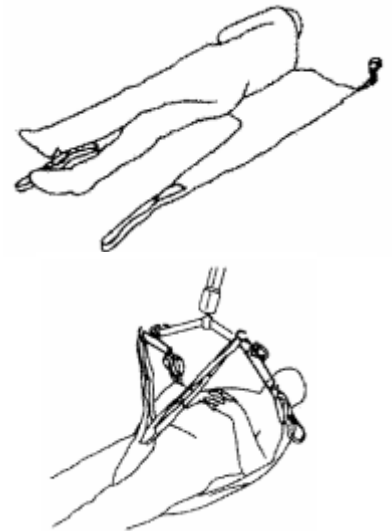

## 3.3 Attaching loop fixing to Carry Bar







- The four main lifting straps can now be fitted onto the carry bar attachment point.
- Loop the straps onto the carry bar fixing point as shown below:

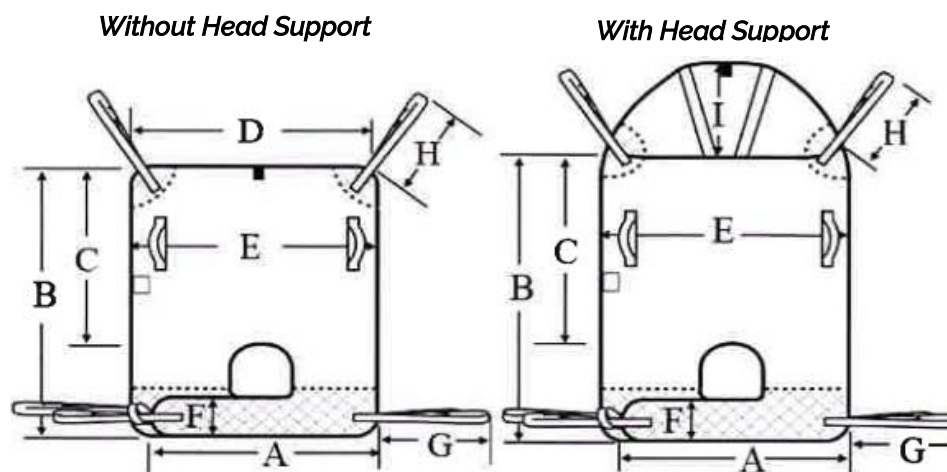

## 4 Technical Specification

### 4.1 Sling Dimensions



Sling Specification Inches & Millimetres						
Dimension (Ref to drawing)	Small	Medium	Large	X Large	XX Large	XXX Large
<b>A</b>	27.2"/690mm	29.1"/740mm	32.3"/820mm	34.6"/880mm	39.4"/1000mm	1100mm
<b>B</b>	32.1"/815mm	33.5"/850mm	34.3"/870mm	34.3"/900mm	36.6"/930mm	1050mm
<b>C</b>	23"/585mm	24.2"/615mm	25.8"/655mm	26.4"/670mm	28.7"/730mm	830mm
<b>D</b>	31.9"/810mm	33.5"/820mm	32.3"/850mm	36.2"/920mm	42.5"/1080mm	1180mm
<b>E</b>	37.4"/950mm	40.6"/1030mm	42.5"/1080mm	46.5"/1180mm	50.8"/1290mm	54.7"/1390mm
<b>F</b>	6.5"/165mm	6.5"/165mm	6.5"/165mm	6.5"/165mm	6.5"/165mm	6.5"/165mm
<b>G</b>	23.2"/590mm	23.2"/590mm	23.2"/590mm	23.2"/590mm	23.2"/590mm	23.2"/590mm
<b>H</b>	12.2"/335mm	12.2"/335mm	12.2"/335mm	14"/355mm	14"/355mm	14"/355mm
<b>I</b>	13.8"/350mm	13.8"/350mm	13.8"/350mm	14"/355mm	14"/355mm	14"/355mm
<b>Colour Code Binding</b>	Red 	Yellow 	Green 	Blue 	Black 	Pink 

Sling Weight Specifications Lbs & Kg						
	Small	Medium	Large	X Large	XX Large	XXX Large
<b>Safe Working Load (SWL)</b>	440lbs / 200kg	440lbs / 200kg	440lbs / 200kg	440lbs / 200kg	660lbs / 300kg	660lbs / 300kg
<b>Product Weight</b>	< 1kg	< 1kg	>2kg	>2kg	>2kg	>2kg

Table 4.1-1

## **5 Environmental Conditions**

The sections below will give detailed information regarding the environmental conditions the product should maintain throughout its life cycle. Failure to adhere to these conditions may negatively impact the function of the product. If you are unsure of any environmental conditions, always seek advice.

### **5.1 Operating Environment**

The sling is intended for use within the professional health care facility environment as well as the home health care environment. The sling is not suitable for any other environment or special environments.

The sling is not intended to be used in environments where there are rapid changes in the environmental temperature and humidity during intended use.

#### **5.1.1 Normal Operating Conditions**

+5°C to +40°C (41°F to 104°F) at a relative humidity between 15% to 90% RH, non-condensing but not requiring a water vapour pressure greater than 50hPa and atmospheric pressure between 700hPa to 1060hPa.

### **5.2 Storage Conditions**

The sling is intended for internal storage within normal environmental conditions. The sling is intended to be stored in a dry room.

It is not intended to be stored in environments where there are rapid changes in the environmental temperature.

When storing the sling, ensure that the product has been cleaned and dried. For further information, refer to the 'cleaning' section instructions.

#### **5.2.1 Shipping and Storage Conditions**

-25°C to +5°C (-13°F to 41°F) with any humidity level.

+5°C to +35°C (41°F to 95°F) at a relative humidity up to 90%.

+35°C to 70°C non-condensing at a water vapour pressure up to 50hPa.

### **5.3 Standards Applied**

The standards that have been applied to the device are as follows:

- IEC 62366-1:2015: Medical devices - Part 1: Application of usability engineering to medical devices
- BS EN ISO 14971:2019: Medical devices. Application of risk management to medical devices
- BS EN ISO 10535:2006: Ceiling Lifts for the transfer of disabled persons. Requirements and test methods
- Medical Device Regulation 2017/745 - CE marking of Medical Devices
- UK Medical Device Regulation 2002: UKCA marking of medical devices.
- EN ISO 15223-1:2016 - Medical devices. Symbols to be used with medical device labels, labelling and information to be supplied. General requirements
- EN 1041:2008+A1:2013 - Information supplied by the manufacturer of medical devices.
- BS ISO 20417:2021 – Medical Devices – Information to be supplied by the manufacture.



## 6 Daily Checks

Inspection is to be completed prior to each use by the user of the sling.



Should any of the components in the table below fail the inspection, **DO NOT** use the sling. Contact your local authorised dealer – contact details are on the last page of this manual.

### Check list before use:

Component	Inspection required
<p style="text-align: center;"><b>Sling</b></p>	<p style="text-align: center;">Ensure the sling is the correct size and type for the patient and has been cleaned.</p>
<p style="text-align: center;"><b>Celing Lift and Sling</b></p>	<p style="text-align: center;">Check the Lift and sling are compatible.</p>
<p style="text-align: center;"><b>Labels</b></p>	<p style="text-align: center;">Check all labels are legible and show the SWL (safe working load) and unique identifier and size</p>
<p style="text-align: center;"><b>Sling Loops</b></p> 	<p style="text-align: center;">Inspect the condition and integrity of the sling loops, ensuring there is no sign of fraying, tears, or deterioration.</p>
<p style="text-align: center;"><b>Buckle &amp; Velcro fixings</b></p> 	<p style="text-align: center;">Inspect the condition and integrity of the Velcro and buckle fixings. Ensuring the Velcro is clean and free of fibres/fluff and the buckle clips securely together.</p>
<p style="text-align: center;"><b>Fabric and Seams</b></p> 	<p style="text-align: center;">Inspect the condition and integrity of the sling body and seams, ensure all fabric and stitching are intact and are without any tears or signs of deterioration.</p>

*Table 6-1*



## 7 Cleaning



To reduce the risk of cross-contamination it is recommended to clean the sling before use by a different person.

To ensure proper care of the sling and maintain its longevity, follow these washing guidelines.

### 7.1 Washing guidelines

- a. The sling should be laundered with soap or detergent at a temperature of 50°C.
- b. Before washing ensure that all Velcro® fastenings and buckle are fully closed to prevent any damage during the wash cycle.
- c. For best results, use a non-biological washing detergent only, do not include conditioners and fabric softeners. Ensure a thorough rinse to prevent deterioration of the sling fabric and skin irritation.
- d. Customers wishing to use biological washing detergent are advised that this may ultimately affect the fabric integrity and longevity of the product. Additionally, it is important to note that any use of biological washing detergent will invalidate any future warranty claims, as it may cause possible deterioration in the product's function due to not following the manufacturers guidelines.
- e. Avoid using bleach when washing, particularly hypochlorite as it can cause structural damage to the sling.
- f. Ensure any head stays are removed prior to washing. Refit the head stays after washing.
- g. Never iron any sling product.
- h. Temperatures above 80°C will cause shrinkage and structural damage, it is always best to maintain a 50°C cycle wash where possible, but the temperature will need to be increased during disinfection.

If disinfection is necessary for a more thorough clean, you should follow the following temperature guidelines:

- 10-minute wash, at a temperature of 65°C.
- 3-minute wash, at a temperature of 72°C.

### 7.2 Drying Guidelines:

It is important to follow the proper drying guidelines to ensure the longevity and integrity of the sling fabric. Please see the following recommendations:

- a. Always refer to the label attached to the sling fabric for specific drying instructions.
- b. We highly recommend air drying as the optimal method, to preserve the fabric's integrity and extend its lifespan.
- c. If using a tumble dryer, please select a low heat setting with a short cycle. Avoid using high heat, as overheating may cause deterioration in the material components.
- d. To prevent overheating and potential damage to the material components and sling fabric, refrain from placing the product on heaters, steam pipes, or radiators.

By following these drying guidelines, you can ensure the longevity and quality of the sling fabric.



## 8 Servicing

To ensure the safety and continued good function of your sling, it is recommended to have a competent person perform routine maintenance every 6 months, this will ensure that the product meets the required standards. It is important to document the maintenance history of the product in the log located at the back of this user manual after each service.

To reduce the risk of injury, no checks are to be carried out on the sling while in use.

**Service must be completed by a competent person only.**

Contact your local authorised dealer if you:

- Need more information.
- Have any questions about the use or maintenance of your sling.
- Notice any change in the performance.
- Want to report an unexpected occurrence.
- Want to arrange a service.
- Need to ascertain necessary information for replacement parts and components.

The expected product lifetime is **5 years**. This is dependent on usage and compliance with maintenance. Regular maintenance checks on the product will increase the expected lifetime.

## 9 Disposal

With efforts to improve the environment and reduce waste, where possible our products have been manufactured with recyclable materials. Below are our guidelines on recyclable materials and being environmentally friendly.

Please observe the local laws on recycling and respect the current laws for disposal within the community the product is being used within. If there is any uncertainty of the below guidelines, contact your local authorities to determine the proper method of disposal of potentially biohazardous parts and accessories.

Fully Recyclables	Consideration when Recycling
Plastic Clips and Mouldings	Sling Textile
Initial packaging of the product (cardboard)	

**Table 12-1**

When the sling has completed its life cycle and can no longer perform to its intended use safely, the product should be decommissioned by a competent person.



The product may be contaminated and must be disinfected before recycling or disposal. See section on 'Cleaning' for details of how to do this

## **10** Warranty

It is impossible for all the risks to be eliminated from use of this product, but to reduce risk and improve safe and proper use, the user should always read and understand the user manual before use. Product failure may occur due to lack of maintenance and care, misuse, unauthorised and improper servicing or alterations, improper storage, and environmental use, or through normal use wear and tear. These factors are all beyond the control from the manufacturer. These risks are taken on by the users.

Once registered, the manufacturer will provide a 1-year warranty period for the sling against all manufactured defects to the registered customer. The warranty is valid if the product has maintained its intended use and the user manual instructions have been followed. The warranty will not extend to the use of the product when used contrary to the user manual. This guarantee does not affect or in any way limit your statutory rights.

1. The liability of the manufacturer under the terms of this guarantee shall be limited to the replacement of the defective part(s) to the sales distributor, dealer, agent, person, or entity which purchased the equipment from the manufacturer. In no event shall the manufacturer incur liability for any consequential or unforeseeable losses.
2. This equipment guarantee shall be void if the equipment is not serviced by Mackworth or its authorised service engineers, in accordance with the manufacturer's recommendations, or if any unauthorised persons carry out work on the equipment.
3. This guarantee does not apply to failure attributable to normal wear and tear, damage by natural forces, user neglect or misuse or deliberate destruction.
4. Do not attempt to repair the product yourself, or the warranty is void.

## 11 Inspection Record History

Complete this section after each service, repair inspection and/or maintenance.

Date:	Time:
Service Type: Service Inspection <input type="checkbox"/> Repair <input type="checkbox"/> Other <input type="checkbox"/>	
Completed By: ..... (Printed name) ..... (Signature)	
Company: .....	
Remarks & Actions Taken:	
Product Left in A Safe & Usable Condition: Yes <input type="checkbox"/> No <input type="checkbox"/> (if no explain in actions above)	
Date:	Time:
Service Type: Service Inspection <input type="checkbox"/> Repair <input type="checkbox"/> Other <input type="checkbox"/>	
Completed By: ..... (Printed name) ..... (Signature)	
Company: .....	
Remarks & Actions Taken:	
Product Left in A Safe & Usable Condition: Yes <input type="checkbox"/> No <input type="checkbox"/> (if no explain in actions above)	
Date:	Time:
Service Type: Service Inspection <input type="checkbox"/> Repair <input type="checkbox"/> Other <input type="checkbox"/>	
Completed By: ..... (Printed name) ..... (Signature)	
Company: .....	
Remarks & Actions Taken:	
Product Left in A Safe & Usable Condition: Yes <input type="checkbox"/> No <input type="checkbox"/> (if no explain in actions above)	
Date:	Time:
Service Type: Service Inspection <input type="checkbox"/> Repair <input type="checkbox"/> Other <input type="checkbox"/>	
Completed By: ..... (Printed name) ..... (Signature)	
Company: .....	
Remarks & Actions Taken:	
Product Left in A Safe & Usable Condition: Yes <input type="checkbox"/> No <input type="checkbox"/> (if no explain in actions above)	
Date:	Time:
Service Type: Service Inspection <input type="checkbox"/> Repair <input type="checkbox"/> Other <input type="checkbox"/>	
Completed By: ..... (Printed name) ..... (Signature)	
Company: .....	
Remarks & Actions Taken:	
Product Left in A Safe & Usable Condition: Yes <input type="checkbox"/> No <input type="checkbox"/> (if no explain in actions above)	

Date:	Time:
Service Type:    Service Inspection <input type="checkbox"/> Repair <input type="checkbox"/> Other <input type="checkbox"/>	
Completed By: ..... (Printed name) ..... (Signature)	
Company: .....	
Remarks & Actions Taken:	
Product Left in A Safe & Usable Condition: Yes <input type="checkbox"/> No <input type="checkbox"/> (if no explain in actions above)	
Date:	Time:
Service Type:    Service Inspection <input type="checkbox"/> Repair <input type="checkbox"/> Other <input type="checkbox"/>	
Completed By: ..... (Printed name) ..... (Signature)	
Company: .....	
Remarks & Actions Taken:	
Product Left in A Safe & Usable Condition: Yes <input type="checkbox"/> No <input type="checkbox"/> (if no explain in actions above)	
Date:	Time:
Service Type:    Service Inspection <input type="checkbox"/> Repair <input type="checkbox"/> Other <input type="checkbox"/>	
Completed By: ..... (Printed name) ..... (Signature)	
Company: .....	
Remarks & Actions Taken:	
Product Left in A Safe & Usable Condition: Yes <input type="checkbox"/> No <input type="checkbox"/> (if no explain in actions above)	
Date:	Time:
Service Type:    Service Inspection <input type="checkbox"/> Repair <input type="checkbox"/> Other <input type="checkbox"/>	
Completed By: ..... (Printed name) ..... (Signature)	
Company: .....	
Remarks & Actions Taken:	
Product Left in A Safe & Usable Condition: Yes <input type="checkbox"/> No <input type="checkbox"/> (if no explain in actions above)	
Date:	Time:
Service Type:    Service Inspection <input type="checkbox"/> Repair <input type="checkbox"/> Other <input type="checkbox"/>	
Completed By: ..... (Printed name) ..... (Signature)	
Company: .....	
Remarks & Actions Taken:	
Product Left in A Safe & Usable Condition: Yes <input type="checkbox"/> No <input type="checkbox"/> (if no explain in actions above)	

Date:	Time:
Service Type:    Service Inspection <input type="checkbox"/> Repair <input type="checkbox"/> Other <input type="checkbox"/>	
Completed By: ..... (Printed name) ..... (Signature)	
Company: .....	
Remarks & Actions Taken:	
Product Left in A Safe & Usable Condition: Yes <input type="checkbox"/> No <input type="checkbox"/> (if no explain in actions above)	
Date:	Time:
Service Type:    Service Inspection <input type="checkbox"/> Repair <input type="checkbox"/> Other <input type="checkbox"/>	
Completed By: ..... (Printed name) ..... (Signature)	
Company: .....	
Remarks & Actions Taken:	
Product Left in A Safe & Usable Condition: Yes <input type="checkbox"/> No <input type="checkbox"/> (if no explain in actions above)	
Date:	Time:
Service Type:    Service Inspection <input type="checkbox"/> Repair <input type="checkbox"/> Other <input type="checkbox"/>	
Completed By: ..... (Printed name) ..... (Signature)	
Company: .....	
Remarks & Actions Taken:	
Product Left in A Safe & Usable Condition: Yes <input type="checkbox"/> No <input type="checkbox"/> (if no explain in actions above)	
Date:	Time:
Service Type:    Service Inspection <input type="checkbox"/> Repair <input type="checkbox"/> Other <input type="checkbox"/>	
Completed By: ..... (Printed name) ..... (Signature)	
Company: .....	
Remarks & Actions Taken:	
Product Left in A Safe & Usable Condition: Yes <input type="checkbox"/> No <input type="checkbox"/> (if no explain in actions above)	
Date:	Time:
Service Type:    Service Inspection <input type="checkbox"/> Repair <input type="checkbox"/> Other <input type="checkbox"/>	
Completed By: ..... (Printed name) ..... (Signature)	
Company: .....	
Remarks & Actions Taken:	
Product Left in A Safe & Usable Condition: Yes <input type="checkbox"/> No <input type="checkbox"/> (if no explain in actions above)	

Date:	Time:
Service Type:    Service Inspection <input type="checkbox"/> Repair <input type="checkbox"/> Other <input type="checkbox"/>	
Completed By: ..... (Printed name) ..... (Signature)	
Company: .....	
Remarks & Actions Taken:	
Product Left in A Safe & Usable Condition: Yes <input type="checkbox"/> No <input type="checkbox"/> (if no explain in actions above)	
Date:	Time:
Service Type:    Service Inspection <input type="checkbox"/> Repair <input type="checkbox"/> Other <input type="checkbox"/>	
Completed By: ..... (Printed name) ..... (Signature)	
Company: .....	
Remarks & Actions Taken:	
Product Left in A Safe & Usable Condition: Yes <input type="checkbox"/> No <input type="checkbox"/> (if no explain in actions above)	
Date:	Time:
Service Type:    Service Inspection <input type="checkbox"/> Repair <input type="checkbox"/> Other <input type="checkbox"/>	
Completed By: ..... (Printed name) ..... (Signature)	
Company: .....	
Remarks & Actions Taken:	
Product Left in A Safe & Usable Condition: Yes <input type="checkbox"/> No <input type="checkbox"/> (if no explain in actions above)	
Date:	Time:
Service Type:    Service Inspection <input type="checkbox"/> Repair <input type="checkbox"/> Other <input type="checkbox"/>	
Completed By: ..... (Printed name) ..... (Signature)	
Company: .....	
Remarks & Actions Taken:	
Product Left in A Safe & Usable Condition: Yes <input type="checkbox"/> No <input type="checkbox"/> (if no explain in actions above)	
Date:	Time:
Service Type:    Service Inspection <input type="checkbox"/> Repair <input type="checkbox"/> Other <input type="checkbox"/>	
Completed By: ..... (Printed name) ..... (Signature)	
Company: .....	
Remarks & Actions Taken:	
Product Left in A Safe & Usable Condition: Yes <input type="checkbox"/> No <input type="checkbox"/> (if no explain in actions above)	

**User notes:**

**Dealer/service contact details:**

**Contact details:**

**Mackworth USA**  
54 West Industrial Drive  
O'Fallon, MO 63366 USA  
314-889-1000  
[www.mackworthusa.com](http://www.mackworthusa.com)

## Disclaimer

While every effort has been made to ensure the accuracy of information contained in this manual, no liability can be accepted by Mackworth for any errors or omissions. Mackworth operates a policy of continuous improvement. Specifications and other data are subject to change without notice.

