

mackworth

TX Advanced Ceiling Track Lift

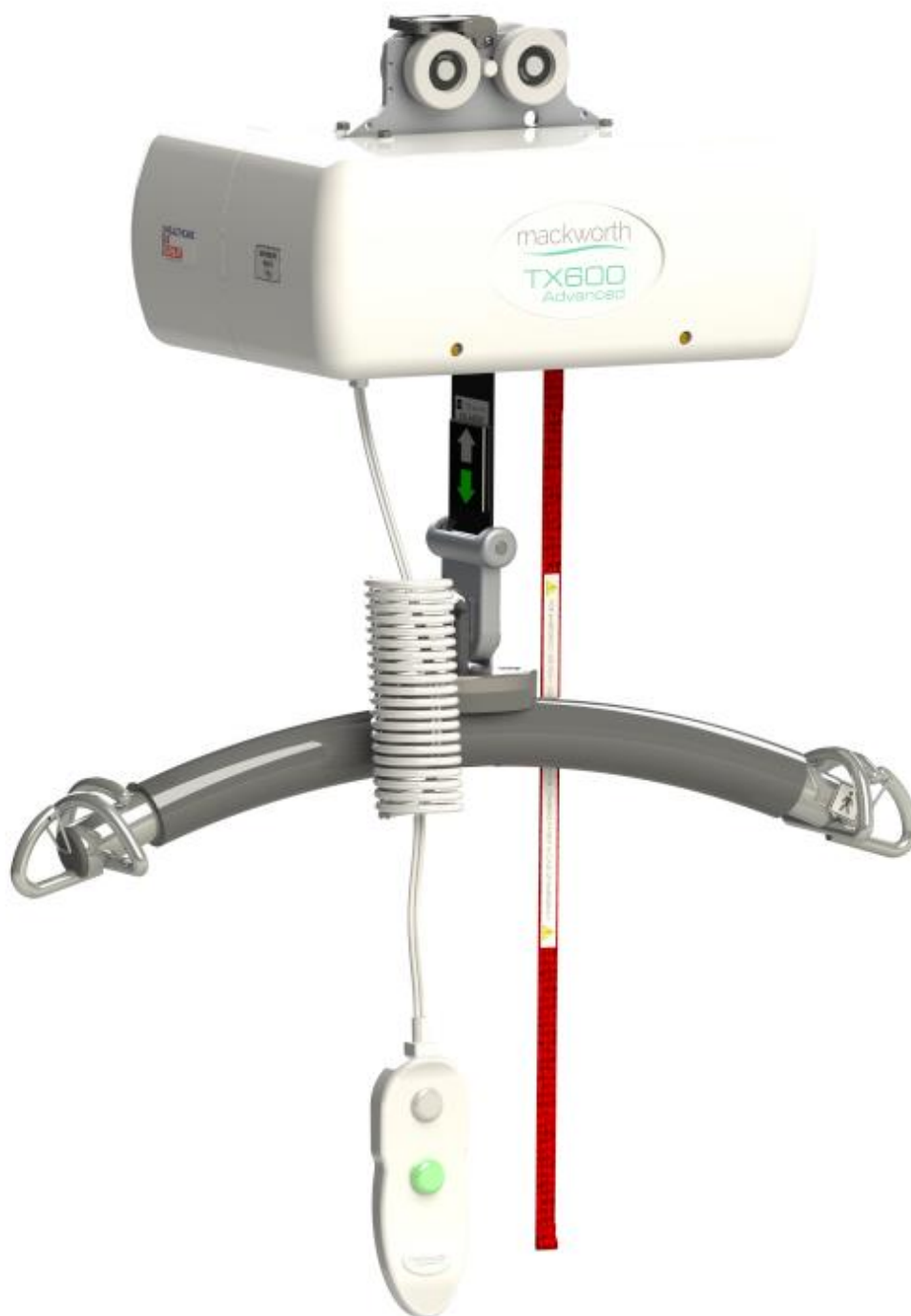

User Manual

1	Introduction	4
1.1	Intended Use	4
1.2	Manufacture	4
1.3	European Authorised Representative	4
1.4	Symbols Used	5
1.5	Contraindications / Limitations	6
1.6	Safety Instructions and Warnings	6
1.7	Electromagnetic Compatibility (EMC) Statement	9
2	Configurations and Key Components	11
2.1	Product Configurations	11
2.2	Key Components	12
3	Applied Parts	13
3.1	Body Floating (BF) Applied Parts	13
3.1.1	Carry Bar	13
3.1.2	Slings	14
3.2	Handset	15
3.2.1	Handset Storage	15
4	Ceiling Lift Operation	16
4.1	Turning the Ceiling Lift ON and OFF	16
4.2	Raising and Lowering the Carry Bar	16
4.3	Traversing the Ceiling Lift	17
4.3.1	Manual Traverse Ceiling Lift	17
4.3.2	Powered Traverse Ceiling Lift	17
4.4	Charging the Ceiling lift	18
4.4.1	Standard Charging	18
4.4.2	Constant Charge	18
4.5	Emergency Operation	19
4.5.1	Emergency Stopping	19
4.5.2	Emergency Lowering	19
4.5.3	Manual Emergency Lowering	19
4.6	Turntable	20
4.6.1	Manual Turntable Operation	20
4.6.2	Powered Turntable Operation	21
5	Technical Specification	22
5.1	Ceiling lift Dimensions	22
5.2	Specifications	23
5.3	LCD and LED Indications	24
5.4	Standards Applied	24
6	Environmental Conditions	25
6.1	Operating Environment	25
6.1.1	Normal Operating Conditions	25
6.2	Storage Conditions	25
6.2.1	Shipping and Storage Conditions	25

7	Daily Checks	26
7.1	Lift Tape Caution	26
8	Cleaning	27
8.1	Ceiling lift Cover Cleaning	27
8.2	Lift Tape Cleaning	27
8.3	Disinfecting	27
9	Servicing	29
10	Troubleshooting	30
11	Disposal	31
12	Warranty	31
13	Service Record History	32

1 Introduction

This manual includes the TX Advance 440 and 600 ceiling track lifts, along with all variants and various track types.



Please read and understand this manual in its entirety before using your ceiling track lift. The information in this manual is important for the safety of anyone near the ceiling lift and must be read and understood to help prevent injuries. It is also crucial to the proper operation and maintenance of the ceiling track lift.

This user manual should be kept safe for future reference. Contents of this manual are subject to change without prior written notice.

Should any questions arise from reviewing this manual, contact your local authorised representative.

If, during the use of this device a serious incident has occurred, please report it to the manufacturer and to your national authority.

1.1 Intended Use

The ceiling track lift is a raising and lowering aid used to transfer people safely and is designed to be used in combination with a ceiling track and slings, together these three items make up the ceiling track lift system. The lift makes it possible to move mobility impaired individuals with minimal strain or risk to the caregiver, while providing complete safety, dignity and comfort for the person being moved. It can raise up an individual from one location, such as a bed, move the individual along the track to another location and finally lower the individual, such as into a chair or a bath. The lift is designed for internal use only. No other environments are suitable.

The ceiling lift is designed to be operated by both professional health care workers and home health care workers who may not have a specific range of skills in health care. Typical home care users may include, but is not limited to, teachers, medics, paramedics, carers, family, and friends. Focusing on the dignity and wellbeing of the person being moved, the simple to use lift maximises the amount of care provided to the person.

You may need to seek a specialist advice on how to assist some people with specific moving and handling needs. Sources of advice include, but is not limited to, professional bodies and organisations, occupational therapists, physiotherapists, manual handling advisers and ergonomists with experience in health and social care.

1.2 Manufacture

The product is manufactured at the address below:



Prism Medical UK

Unit 1, Tir Llwyd Industrial Estate, St Asaph Avenue, Kinmel Bay, Conwy, LL18 5JZ
Telephone number: 01924 840100.

1.3 European Authorised Representative

The address of the European Authorised Representative for this product:



European Healthcare & Device Solutions (Ireland) Ltd.
Stratton House, Bishopstown Road,
Cork, Ireland.
T12 Y9TC.
Telephone number: +353(86)2280846.

1.4 Symbols Used

The table below includes all symbols from BS EN ISO 15223-1:2021 that can be found in this manual and on the product and what they represent. Refer to this table when you are unsure of what a symbol represents.















			
Place of Manufacture	Country of Manufacture	Serial number	Catalogue Number
			SWL
Caution – see instructions for use	Consult instructions for use	UK Conformity Assessed	Safe Working Load
			
For internal use only	Packaging indicator – Keep dry	Do not use if package is damaged	Packaging indicator – This way up
			
Fragile, handle with care	Please observe local laws on recycling	Non-sterile	Atmospheric pressure limitation
			IP_{N1N2}
Temperature range	Humidity range	Class II Equipment	Degree of protection provided by enclosure. N1: Ingress of particles N2: Ingress of water
			
Type 'B' applied part	Type 'BF' applied part	European Authorised Representative	

Table 1-1

1.5 Contraindications / Limitations

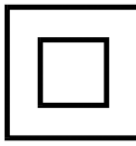
There are no known "contraindications" associated with the usage of ceiling track lift, provided it is used as per the manufacturer's recommendations and guidelines. However, it is recommended that a client specific assessment is completed by a trained and knowledgeable health care professional to determine the method of transfer and use.

The manufacturer does not recommend a required number of operators for the use of our products. This information and recommendation can only be provided after a thorough personalised, case specific assessment, as there are many factors that can influence these decisions.

Limitations of the lift include:

- The lift should only be operated by competent and trained persons.
- The lift should only be used with patients weighing under the safe working load of the lift.
- Between the lift, sling, carry bar and track system, the lowest safe working load of the components should not be exceeded.
- The lift is only to be used within the track it is installed into. Lifts must only be relocated by an authorised person.
- The lift is only compatible with the allocated slings found within this manual.
- Lifts are designed for human transfer only. There is no other application to this product.
- The operator of the lift must always pay attention to the well-being of the patient. Patients should not be left unsupervised during operation.
- The lift is not designed for self-lifting. A carer must operate the lift during use.

1.6 Safety Instructions and Warnings

Ensure to read and understand all the statements below, for the safety of the caregivers and users, along with warranty requirements. Failure to comply with warnings in this manual may result in; injury to the operator and/or client and/or damage to the lift or related components.

- If you are unsure on the correct use of this product, please contact the manufacturer or a professional for further information or training.
- The ceiling track lift and associated accessories are not toys. Do not use it for unsafe practices. Do not allow children to play with the product or any of its components. The lift should not be used for any practice except its intended use.
- In facilities where more than one operator will be responsible for using the lift, it is important that all such members be trained on the product prior to use. A training program should be established by the facility to acquaint new operators with this equipment.
- Your guarantee is void if persons unauthorised by the manufacturer perform work on the lift.
- To maintain optimum function, the product should be inspected and maintained on a regular basis. See section 'Daily checks, Servicing and Cleaning' within this user manual.
- This user manual provides a list of standard accessories that have been approved.
- The product and the associated accessories are intended only for lifting and transferring of a person. The manufacturer will not be responsible for any damage caused by the misuse, neglect, or purposeful destruction of the equipment and/or its associated components.
- Any accessories used with the product should be checked before each use to ensure that they are in good working order. Check for signs of wear and ensure that all labels are legible. Report any unusual wear to your local authorised dealer.

- Ensure that a clear space is maintained around the lift. Before using the ceiling lift, always check for and move away any obstacles.
- Never leave a user unattended in the ceiling lift.
- If additional accessories have been supplied with the Lift, refer to the instructions included with those items.
- The lift must be installed on the ceiling track prior to use.
- The lift must be installed only by persons authorized by the manufacturer.
- Under no circumstance should the lift, track, sling, or entire system be put in control of a person who has not been properly trained in the use and care of this equipment. Failure to adhere to this warning may result in serious injury to the operator, and / or the individual being lifted / transferred.
- Unauthorised modifications on this product may affect its safety. The manufacturer will not be held responsible for any accident, incident or deficiencies of performance that occur because of any unauthorised modification to its products. Your guarantee is void if any modifications are made that are not authorised by the manufacturer. This includes, but is not limited to, shortening the length of the emergency red cord – for example, tying it up or cutting it.
- There are no user serviceable parts inside the cover of the lift, likewise for any components of the associated parts. Do not remove cover screws, or open the lift unit, as this will VOID THE GUARANTEE/WARRANTY.
- Never expose the lift directly to water. Your guarantee does not cover any misuse or abuse of the lift system.
- The ceiling lift and associated accessories, track and sling(s) are intended only for lifting and transferring of a person. We will not be responsible for any damage caused by the misuse, neglect, or purposeful destruction of the lift, and/or its associated components.
- The installation of the lift and its associated parts are certified to a maximum load of 440 lb/600 lb, depending on the model. Do not exceed the maximum rated load of any of the components.
- There is a risk of explosion if the ceiling lift is used in the presence of flammable anaesthetics.
- Your ceiling lift is for human lifting. Do not use it, or allow it to be used, for any other purpose.
- In areas where children are prone to be present be vigilant when operating the lift.
- Protecting the people present, visually monitor sling loop connection points during raising, lowering and transfer stages so the sling remains firmly attached to the carry bar.
- To reduce the risk of unintended use, when the lift is not in use remove the sling(s) from the product to prevent entrapment or strangulation should the device be tampered with.
- The lift batteries are not a user serviceable part. Contact your local authorised dealer to arrange for replacement.
- Before initial use, the lift unit must be charged for approximately 8 hours. Refer to section 'Charging the Lift'. The handset must also be connected to the lift. To connect the handset, refer to the section 'Connecting the Handset to the Lift'.
- Between the Ceiling Lift, Carry Bar, Sling and other accessories, the lowest maximum load shall always be used.

- A risk assessment must be performed before using any other manufactured sling, carry bar or ceiling track to ensure 'safe' use can be established.
- Risk of strangulation: Please make sure handset cable and lift tape are always clear of all persons.
- Risk of impact with carry bar: Please take care to ensure the carry bar is clear of the person in the sling when preparing to raise/lower and move them to avoid any contact with that person.
- Risk of collision: The person operating the lift should make sure that when raising, lowering, or moving the lift that no people or objects will obstruct, be injured or damaged by the movement.
- Ensure that the person being hoisted is always raised clear of the floor when using the hoist.
- Ensure the lift tape is vertically aligned with the hoist when raising or lowering the carry bar. Any deviation from this can cause the tape to fray and result in its potential failure.
- Serious Injury: If, during the use of this device or because of its use a serious incident has occurred, please report it to the manufacturer and to your national authority.
- Electric Shock: Do not insert any objects into the lift case or battery charging station because of potential risk of electric shock. To reduce the risk of electric shock, do not install or operate the battery charger with a damaged cable or if the unit has been dropped or damaged.
- Portable RF Communication Devices: Portable RF communications equipment (including peripherals, such as antenna cables and external antenna) should be used no closer than 30cm (12 inches) to any part of the Ceiling Track Lift, including cables specified by the manufacturer, otherwise degradation of the performance of this equipment could result.
- Vicinity to Other Equipment: Use of this equipment adjacent to or stacked with other equipment should be avoided, as it could result in improper operation. If such use is necessary, this equipment and the other equipment should be observed to verify that they are operating normally.
- Specified Accessories: Use of accessories, transducers, and cables other than those specified or provided by the manufacturer of this equipment could result in increased electromagnetic emissions or decreased electromagnetic immunity of this equipment and result in improper operation.



You may need to seek specialist advice on how to assist some people with specific moving and handling needs. Sources of advice include, but is not limited to, professional bodies and organisations, occupational therapist, physiotherapists, manual handling advisers and ergonomist with experience in health and social care.

1.7 Electromagnetic Compatibility (EMC) Statement

The following statement has been made against the assumption that the user of the system utilises the provided components supplied by the manufacturer of the device to operate the device as intended. DO NOT use any other form of power charge with the system as the manufacturer's adapter has been assessed and complies with the EMC requirements.

This product, has been designed, manufactured, and tested in accordance with the legal requirements for the environment in which the device will be used within.

Pacemakers, defibrillators, and other medical devices should be manufactured in such a manner that they can withstand Electromagnetic Interferences (EMI) in accordance with their associated mandatory European directives and regulations. Please consult the user alert card which would have been issued to the user regarding the use of electrical items for those individuals fitted with these or any other devices.

If users of this equipment are unsure of its compliance to EMC, you can request the confirmation from the manufacturer that the product is manufactured to the appropriate Electromagnetic Compatibility standard.

A brief summary of the tests carried out in accordance with IEC 60601-1-2 is shown in the table below.

The Lift is also classified as Class B according to CISPR 11:2009 for the home health care environment.

The use of the device within the correct area where the intended use is given will have no detrimental effect on other devices that have been tested to their intended respective requirements.

Section	Specification Clause	Test Description	Results	Comments/ Base Standard
Configuration and Mode: Test setup standby				
2.1	4.4.1	General Requirement; Risk Management Process for ME Equipment and ME Systems	Pass	
2.2	5	Identification, Marking and documents	Pass	
Configuration and Mode: Test setup charging				
2.3	7.1.1	Mains Terminal Disturbance Voltage	Pass	CISPR 11: 2009 A1:2010 EN 55016-2-3: 2004 + A1:2005
2.4	7.1.1	Electromagnetic Radiation Disturbance	Pass	CISPR 11: 2009 A1:2010 EN 55016-2-3: 2004 + A1:2005
2.5	7.2.1	Harmonic Current Emissions (AC Power Port)	Pass	EN 61000-3-2: 2014
2.6	7.2.2	Voltage Fluctuations and Flicker (AC Power Port)	Pass	IEC 61000-3-3: 2013
2.7	Table 4	Immunity to Electrostatic discharge (Enclosure Port)	Pass	IEC 61000-4-2 2008
2.8	Table 4	Immunity to Radiated RF Electromagnetic fields (Enclosure Port)	Pass	IEC 61000-4-3: 2006 A2:2010
2.9	Table 4	Immunity to Proximity Fields from RF Wireless Communication Equipment (Enclosure Port)	Pass	IEC 61000-4-3: 2006 A2:2010
2.10	Table 5	Immunity to Surges (AC Power Port)	Pass	IEC 61000-4-5: 2005
2.11	Table 5	Immunity to Electrical Fast Transient / Burst (AC Power Port)	Pass	IEC 61000-4-4: 2012
2.12	Table 5	Immunity to Conduct Disturbances Induced by RF Fields (AC Power Port)	Pass	IEC 61000-4-6: 2013

2.13	Table 5	Immunity to Voltage Dips and Voltage Variations (AC Power Port)	Pass	IEC 61000-4-11: 2004
2.14	Table 5	Immunity to Voltage Interruptions (AC Power Port)	Pass	IEC 61000-4-11: 2004
In-Track charging system stand testing				
2.7	Table 4	Immunity to Electrostatic discharge (Enclosure Port)	Pass	IEC 61000-4-2 2008
Configuration and Mode: Test setup standby				
2.4	7.1.1	Electromagnetic Radiation Disturbance	Pass	CISPR 11: 2009 A1:2010 EN 55016-2-3: 2004 + A1:2005
2.7	Table 4	Immunity to Electrostatic discharge (Enclosure Port)	Pass	IEC 61000-4-2 2008
2.8	Table 4	Immunity to Radiated RF Electromagnetic fields (Enclosure Port)	Pass	IEC 61000-4-3: 2006 A2:2010
2.9	Table 4	Immunity to Proximity Fields from RF Wireless Communication Equipment (Enclosure Port)	Pass	IEC 61000-4-3: 2006 A2:2010
Configuration and Mode: Test set up operating up and down				
2.4	7.1.1	Electromagnetic Radiation Disturbance	Pass	CISPR 11: 2009 A1:2010 EN 55016-2-3: 2004 + A1:2005
2.7	Table 4	Immunity to Electrostatic discharge (Enclosure Port)	Pass	IEC 61000-4-2 2008
2.8	Table 4	Immunity to Radiated RF Electromagnetic fields (Enclosure Port)	Pass	IEC 61000-4-3: 2006 A2:2010
2.9	Table 4	Immunity to Proximity Fields from RF Wireless Communication Equipment (Enclosure Port)	Pass	IEC 61000-4-3: 2006 A2:2010
Configuration and Mode: Test setup standby				
2.1	4.4.1	General Requirement; Risk Management Process for ME Equipment and ME Systems	Pass	
2.2	5	Identification, Marking and documents	Pass	

Table 1-7-1

2 Configurations and Key Components

2.1 Product Configurations

Below is a list of the track profiles that the lift can be installed into through the different configurations. The below profiles must match your pre-installed track for the lift to be installed. The table below includes all the configurations available with this lift.

Figure 2-1-1

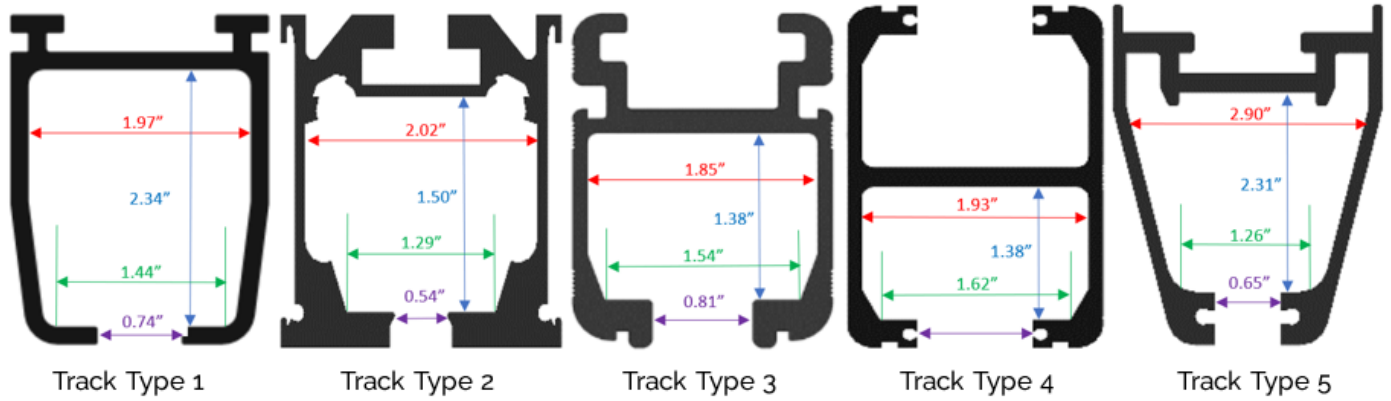

TX400 Advanced Lift Type	Track Type	TX600 Advanced Lift Type	Track Type
TX440 Advanced MT – 122515	Type 1	TX600 Advanced MT – 122520	Type 1
TX440 Advanced MT – 122516	Type 2	TX600 Advanced MT – 122521	Type 2
TX440 Advanced MT – 122517	Type 3	TX600 Advanced MT – 122522	Type 3
TX440 Advanced MT – 122518	Type 4	TX600 Advanced MT – 122523	Type 4
TX440 Advanced MT – 122519	Type 5	TX600 Advanced MT – 122524	Type 5
TX440 Advanced PT – 122617	Type 1	TX600 Advanced PT – 122622	Type 1
TX440 Advanced PT – 122656	Type 3	TX600 Advanced PT – 122666	Type 3
TX440 Advanced PT – 122659	Type 4	TX600 Advanced PT – 122669	Type 4
TX440 Advanced PT – 122662	Type 5	TX600 Advanced PT – 122672	Type 5
TX440 Advanced QRT – 122678	Type 1	TX600 Advanced QRT – 122679	Type 1
TX440 Advanced QRT – 122688	Type 3	TX600 Advanced QRT – 122689	Type 3
TX440 Advanced QRT – 122693	Type 4	TX600 Advanced QRT – 122694	Type 4
TX440 Advanced QRT – 122698	Type 5	TX600 Advanced QRT – 122699	Type 5
TX440 Advanced MTCC – 122616	Type 1	TX600 Advanced MTCC – 122621	Type 1
TX440 Advanced MTCC – 122655	Type 2	TX600 Advanced MTCC – 122665	Type 2
TX440 Advanced MTCC – 122658	Type 3	TX600 Advanced MTCC – 122668	Type 3
TX440 Advanced MTCC – 122661	Type 4	TX600 Advanced MTCC – 122671	Type 4
TX440 Advanced MTCC – 122664	Type 5	TX600 Advanced MTCC – 122674	Type 5
TX440 Advanced PTCC – 122619	Type 1	TX600 Advanced PTCC – 122624	Type 1
TX440 Advanced PTCC – 122657	Type 3	TX600 Advanced PTCC – 122667	Type 3
TX440 Advanced PTCC – 122660	Type 4	TX600 Advanced PTCC – 122670	Type 4
TX440 Advanced PTCC – 122663	Type 5	TX600 Advanced PTCC – 122673	Type 5
TX440 Advanced MTPT – 122615	Type 1	TX600 Advanced MTPT – 122620	Type 1
TX440 Advanced PTPT – 122618	Type 1	TX600 Advanced PTPT – 122623	Type 1

Table 2-1-1

Key:

PT = Powered Traverse

MTCC = Manual Traverse Constant Charge

MTPT = Manual Traverse Powered Turntable

MT = Manual Traverse

PTCC = Powered Traverse Constant Charge

PTPT = Powered Traverse Powered Turntable

QRT = Quick Release Track

2.2 Key Components

Please see below to familiarise yourself with the components of the TX Advance Lift. The images below show the contents of the ceiling track lift. If you have not received all the components contact your local dealer immediately – contact details are provided on the last page of this manual.

Item	Description
1	TX Advance Lift
2	Info Label
3	Carry Bar
4	Handset
5	Lift Charger
6	Allen Key
7	User Manual

Table 2-2-1

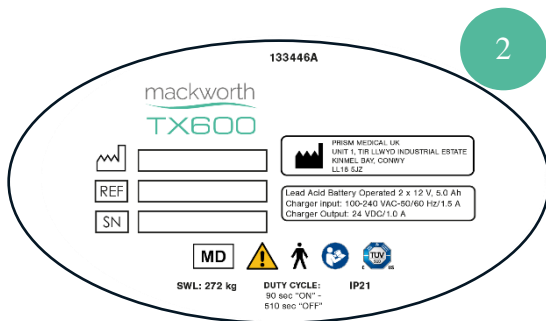

(Located on the side cover)

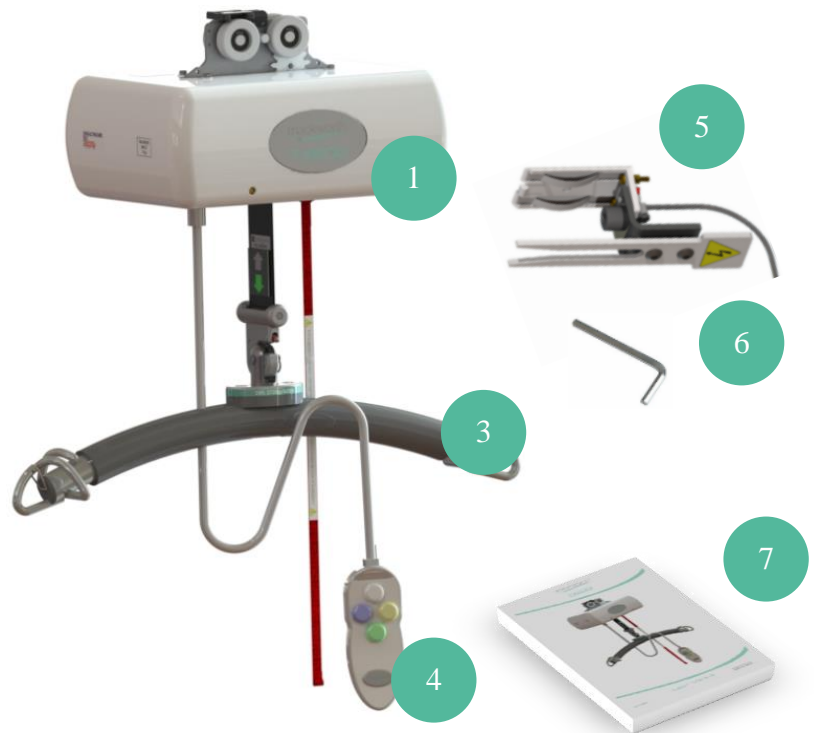

Figure 2-1

3 Applied Parts

3.1 Body Floating (BF) Applied Parts

A Body floating applied part is a detachable component that has medium to long term contact with the user and carer. This includes the carry bar and sling.

Figure 3-1-1



Figure 3-1-2



3.1.1 Carry Bar

The carry bar is an essential applied part of the ceiling lift system. The carry bar incorporates three fixing point options at either end of carry bar, with a safety retaining clip on the outer hook. The carry bar is the link between the ceiling lift and the sling, allowing the user to be transferred.

To attach the carry bar, see the guidelines below:

1. Open the red retaining tab on the QRS by pushing it down. (See figure 3.1.1.1)
2. Hold the carry bar horizontally and insert the boss into the QRS hook. (See figure 3.1.1.2)
3. Pivot the carry bar down to its natural position and release the retaining tab to secure. (See figure 3.1.1.3)



Figure 5-1-4

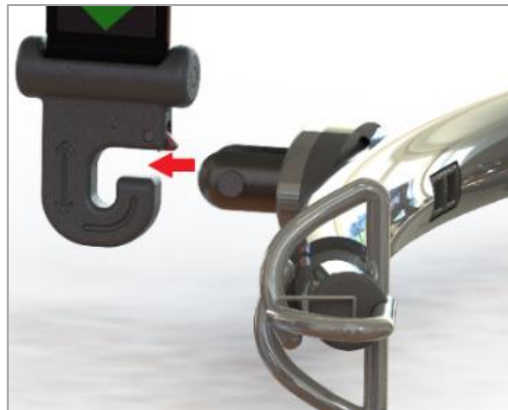

Figure 5-1-5

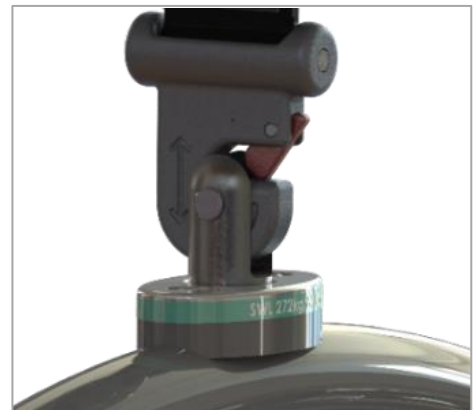

Figure 5-1-6

3.1.2 Slings

The sling is a specially designed fabric accessory that attaches to the ceiling lift through the carry bar. The sling is used to comfortably support the user during transfer. The sling is supplied separately from the ceiling lift at the initial time of purchase. To choose an adequate sling, the user should be assessed prior to purchase for their specific requirements. See list below for compatible slings that are recommended for use with this ceiling lift. For full list and further information on available slings, refer to the sling user manuals.

It is at the user's discretion to use alternative supplied product. In utilising another manufacturer's sling, checks must first be made to ensure the sling is safe to use and meets the requirements of BS EN ISO 10535 before its use and a full risk assessment to be carry out before use.

Always ensure that the sling SWL aligns with the ceiling lift, for any component found across the system, the lowest SWL must never be exceeded.

Mackworth Sling Range	Care-Ability Sling Range
Mackworth Oak	Universal
Mackworth Yew	Universal Deluxe
Mackworth Hazel	Toilet Access
Mackworth Willow	Hammock
Mackworth Beech	Classic Hammock
Mackworth Pine	Deluxe Hammock
	Comfort In Chair Hammock
	Split Leg in Chair Hammock

Table 3-1-2-1

The way the sling is attached to the carry bar needs to be assessed on individual basis and documented in the individual's care plan. Furthermore, the person attaching the sling should reference the slings user manual for the recommended colour coded loop attachment method, as well as the correct fitting requirements for the user. Only after the correct fitting requirements is fully understood should the sling loops be fitted onto the carry bar.

To attach the sling to the carry bar, follow the guidelines below:

1. Pull the safety retaining clip back to access the carry bar hook. (See figure 3.1.2.1)
2. Place the chosen sling loop onto the hook. (See figure 3.1.2.2)
3. Release the safety retaining clip to secure the loop onto the carry bar. (See figure 3.1.2.3)



Make sure the required loop(s) are on the correct hooks and are correctly positioned.



Figure 3-1-2-1



Figure 3-1-2-2



Figure 3-1-2-3

To remove the sling, simply reverse the process – pull back on the spring locking mechanism, lift the loop out of the hook and release the locking mechanism.

3.2 Handset

The handset is an essential applied part of the ceiling lift system. The handset has two to six buttons depending on the chosen ceiling lift. The handset is used to operate the ceiling lift, including raising and lower the carry bar, traversing the ceiling lift along the track, and operating powered auxiliaries (such as turntables).

We recommend that handset should never be detached from the ceiling lift, but in an instance that the handset becomes inadvertently detached. See guidelines below to reattach the handset.

1. The handset grommet attaches to the airline grommet on the underside of the ceiling lift. Align the profile of the grommets together and insert the handset brass inserts into the air grommet holes. See images below for reference. Make sure that the handset is fully inserted onto the airline grommet.
2. Test the handset by operating each button to ensure that the command functions as intended. (See operating instructions for further details)

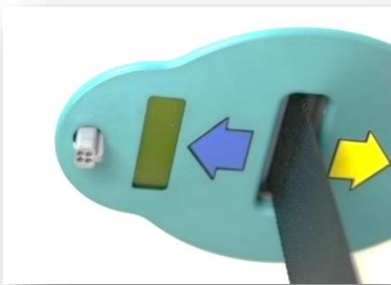

Figure 3-2-1

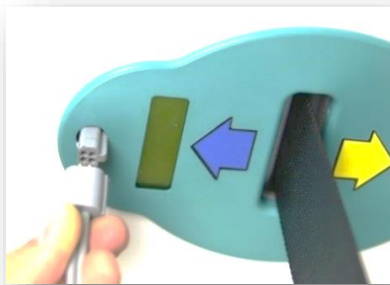

Figure 3-2-2



Figure 3-2-3



A sturdy ladder or steps may be required to access the underside of the ceiling lift to attach the hand controller. Caution should be used when this is required.

3.2.1 Handset Storage

The Handset is designed to be stored on the carry bar. The Handset has a hook attached to the rear face which will slot nicely onto the carry bar (See figure 3-2-1-1). It is recommended that the Handset be always stored on the carry bar when not in use for safe keeping and easy access.



Figure 3-2-1-1

4 Ceiling Lift Operation

4.1 Turning the Ceiling Lift ON and OFF

This toggle switch has three states, On, Off and E-Lower. These features should only be operated in an emergency, but if the red pull cord has been pulled by accident, to turn the ceiling lift back on, the toggle switch must be pressed vertically into the slot. Once this is done, press any button on the handset to "wake up" the ceiling lift, the display screen will turn on and the LED will display a steady green.



To conserve battery, the ceiling lift will automatically shut off after approximately two minutes of non-use.

Figure 6-1-1

4.2 Raising and Lowering the Carry Bar

To raise and lower the carry bar, operate the grey and green buttons found on the handset. The grey button raises, and the green button lowers the carry bar. This aligns with the arrows found on the lift tape. This applies across all varying handsets.

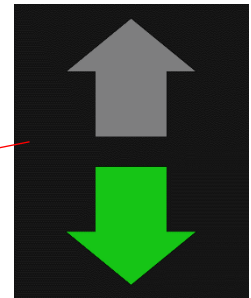
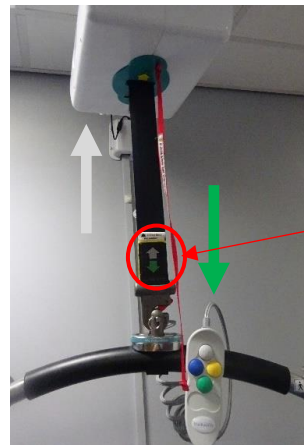

Figure 4-2-1

It is recommended that the operator hold the carry bar with one hand while raising/lowering is being done. This will stop the bar accidentally swaying and/or encountering an individual or close object.

For the same reasons, raise the carry bar above head height when not in use and when traversing the unloaded ceiling lift.



In addition, the lifting tape must be kept vertically in line with the hoist when raising or lowering the carry bar. Any deviation from this can cause the tape to fray, leading to potential failure of the hoist. Please note that if the hoist fails due to improper handling, it will not be covered by warranty, and you will be liable for the cost of the replacement tape.

4.3 Traversing the Ceiling Lift



Always use extreme care when moving the ceiling lift along the track. Watch out for and avoid any obstructions that may cause injury to the individual in the sling, damage to the ceiling lift and/or to the obstruction.

NEVER pull the ceiling lift along the track using the handset, sling, or the emergency cord as this could have a detrimental effect on the performance of the ceiling lift.

See the relevant section below for either a manual traverse or a powered traverse ceiling lift.

4.3.1 Manual Traverse Ceiling Lift

The ceiling lift should be moved along the track by following the below guidelines:

1. Lower the carry bar to a suitable height to allow the carer to handle with both hands. Always ensure the user will be at a safe from the floor.
2. Push or pull the carry bar in the required direction for transfer. Ensure transfer is done safely and slowly for maximum user comfort.
3. Always ensure the direction of travel is clear from any obstacles.

4.3.2 Powered Traverse Ceiling Lift

The ceiling lift should be moved along the track by following the below guidelines:

1. Lower the carry bar to a suitable height to allow the carer to stabilize the ceiling lift with one hand. Always ensure the user will be at a safe from the floor.
2. To traverse the ceiling lift, operate the blue and yellow buttons found on the handset. The buttons are colour coded to correspond with the directional arrows found on the underside of the ceiling lift. Ensure transfer is done safely and slowly for maximum user comfort.



Only in an emergency situation should a powered traversing ceiling lift be moved manually.



Figure 4-3-2-1

4.4 Charging the Ceiling Lift

As standard practice, the ceiling lift should be placed on charge after each use. Keeping the batteries charged regularly and not allowing full discharge, will maintain the lifespan and performance of the batteries. From full discharge, the batteries take up to 8.5hrs before they are fully charged.

The ceiling lift LCD indicates the remaining charge in the batteries. Once the batteries are low, the LCD will display "Low Batt!", the LED will turn orange and the ceiling lift will sound three single audible beeps.

If the ceiling lift has not been charged during the low battery period. The LCD will then display "Up: Inhibit!", the LED will turn red, and the ceiling lift will sound a single audible beep, lasting three seconds. The ceiling lift will no longer lift but will lower to allow the user to exit the ceiling lift.

When the ceiling lift is placed on charge, it may remain connected to the charger indefinitely because the ceiling lift has a built-in regulator, removing the danger of overcharging.

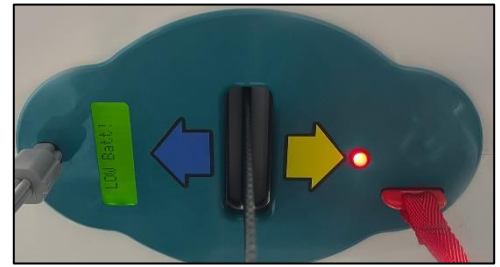

Figure 4-4-1

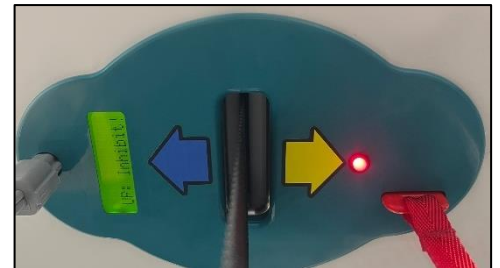

Figure 4-4-2

4.4.1 Standard Charging

The standard ceiling lift is designed for in-track charging. The charging dock will be located at either end of the track system. To begin charging, traverse the ceiling lift into the charging dock. Once contact is made, the LCD will display "Charging" and the LED will begin to flash orange.

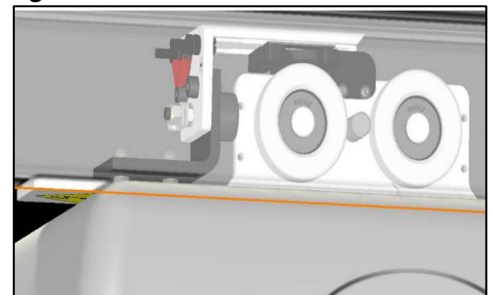

Figure 4-4-1-1

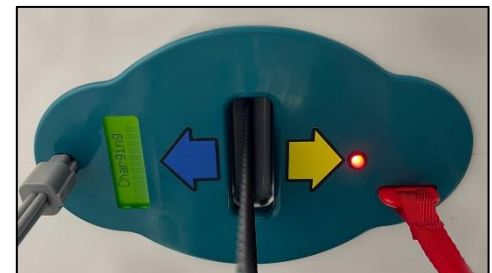

Figure 4-4-2-1



Do not traverse the ceiling lift with excessive force into the dock as this has the potential to damage both the ceiling lift and the charger.

4.4.2 Constant Charge

Ceiling lifts with the constant charge feature allows the ceiling lift to continuously charge up the batteries without being docked in a charging dock. This style of ceiling lift will be always charged resulting in no need for the user to charge the ceiling lift.

4.5 Emergency Operation

The emergency red cord/tab is located on a toggle switch, this switch has three functions, ON, OFF and E-Lower. See diagram for reference. These emergency stopping features must only be used in an emergency.

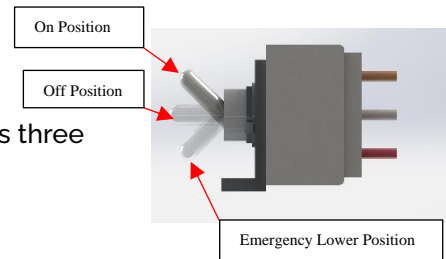

4.5.1 Emergency Stopping

The ceiling lift unit has an emergency shut-off feature that allows the operator to remove power to the ceiling lift.

By pulling the toggle switch down to stage 2 using the red cord, this will remove power from the ceiling lift. This should only be used in an emergency. Once the red emergency cord has been activated, the ceiling lift unit will need to be reset to operate again.

The user should not re-engage the switch to stage 1 once the cord has been pulled. If the emergency stop has been activated, contact your local authorised dealer to report the emergency and where applicable, a service engineer may be sent out to solve the issue with the ceiling lift. Do not continue to use the ceiling lift after using the emergency stop function before contacting the local authorised dealer.



Figure 4-5-1-1

4.5.2 Emergency Lowering

In the event that the DOWN button on the handset does not function, or in power failure situations, the person may be lowered by pulling down and HOLDING the red emergency cord at stage 3 of the toggle switch. In this scenario, the ceiling lift will sound a continuous audible beep until it's released.

Continue to pull down on the emergency red cord until the person is safely lowered to the desired position.

NOTE: The emergency lowering function does not provide a lifting function. The Emergency Lower should only be used in an emergency, such as lowering a patient due to damaged handset etc.

Once the red emergency cord has been activated, the ceiling lift unit will need to be reset to operate again.

The user should not re-engage the switch to stage 1 once the cord has been pulled. If the emergency stop has been activated, contact your local authorised dealer to report the emergency and where applicable, a service engineer may be sent out to solve the issue with the ceiling lift. Do not continue to use the ceiling lift after using the emergency stop function before contacting the local authorised dealer.

4.5.3 Manual Emergency Lowering

The manual emergency lowering should only be used if when the emergency lowering cord fails due to total power loss. The manual E-Lower is a last resort safety feature for when a patient is suspended and cannot be lowered.

To operate, remove the cap from the side cover of the ceiling lift (Figure 4-5-3-1). Insert the 4mm Allen Key that is provided with the ceiling lift, into the motor unit inside the cover (Figure 4-5-3-2). Wind the Allen Key to manually operate the ceiling lift motor and safely lower the patient.

After use, remove the Allen Key and re-insert the cap back into the cover.



Figure 4-5-3-1



Figure 4-5-3-2

4.6 Turntable

The TX Advanced can be used in conjunction with a manual or powered turntable. A turntable will have been pre-installed into the track system, and the understanding of safe use and operation is essential. The turntable is a rotating piece of track that allows the ceiling lift to dock into, rotate and exit into another track system. A turntable is commonly used when there are multiple track systems within a room, to allow the ceiling lift to transfer between each system.

Table 4-6-1

Key Aspects	
TT600 Manual Turntable	TT600 Powered Turntable
Can be used with all ceiling lifts listed within this manual	Can only be used with the ceiling lifts listed in the table below (Table 11)
14 Possible Track Take of Positions	10 Possible Track Take of Positions
Has an SWL of 600lb	Has an SWL of 600lb
End stops are fixed all around the turntable to avoid inadvertent ceiling lift derailing.	End stops are fixed all around the turntable to avoid inadvertent ceiling lift derailing.
Rotation is achieved by using the simple pull cord mechanism	The powered turntable is operated by the ceiling lift when docked, the turntable takes power from the ceiling lift's communications port, and the ceiling lift handset buttons are used to activate the turntable rotation.



When using a higher load rated ceiling lift with the turntable, always ensure that the Turntable SWL is not exceeded.

4.6.1 Manual Turntable Operation

To use the ceiling lift with a manual turntable, follow the generic operation guidelines below:

1. Traverse the ceiling lift into the turntable. (Figure 4.6.1.1)
2. Position the ceiling lift in the centre of the turntable rotating track piece. (Figure 4.6.1.2)
3. Grab hold of the looped pull cord and pull downward to rotate the turntable. The looped cord will match the arrow on the underside of the turntable cover. (black and black, white, and white) (Figure 4.6.1.2 and 4.6.1.3)
4. To rotate the turntable in the opposite direction, pull the other looped pull cord.
5. Continue to pull the looped cord until the rotating track aligns with the exiting track system.
6. Always ensure that the two track pieces are perfectly aligned to allow the ceiling lift to exit the turntable.

(Adjusting the alignment is only required when there are more than four track exits on the turntable, otherwise the internal end bumpers will automatically stop the turntable rotation and will have aligned the exit for you)

7. Once aligned with the track exit, traverse the ceiling lift out of the turntable and into the new track system. (Figure 4.6.1.4)
8. This process applies to entering and exiting all track systems linked to the manual turntable.

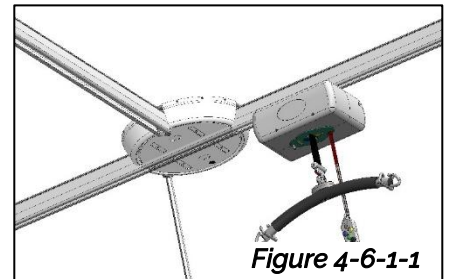

Figure 4-6-1-1

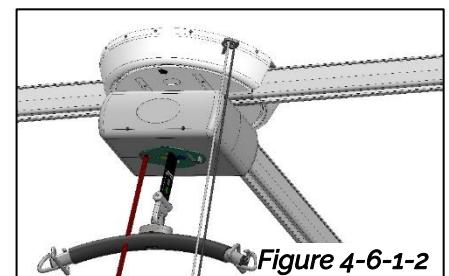

Figure 4-6-1-2

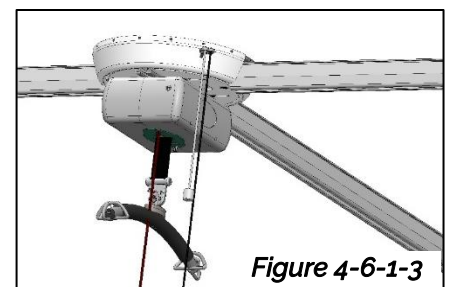

Figure 4-6-1-3

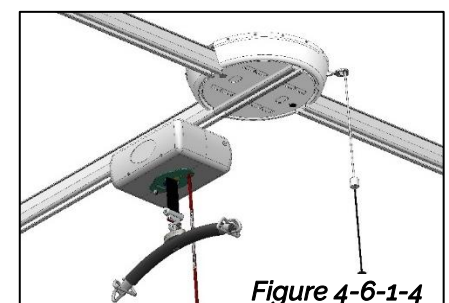

Figure 4-6-1-4

4.6.2 Powered Turntable Operation

Below is a list of all the ceiling lifts that are compatible with the TT600 Powered Turntable.

TX400 Advanced Ceiling Lift Type	Track Type	TX600 Advanced Ceiling Lift Type	Track Type
TX440 Advanced MTPT – 122615	Type 1	TX600 Advanced MTPT – 122620	Type 1
TX440 Advanced PTPT – 122618	Type 1	TX600 Advanced PTPT – 122623	Type 1

Table 4-6-2-1

The powered turntable is powered by the ceiling lift once the ceiling lift has docked into the turntable, there is an auxiliary port on the top of the ceiling lift and underside of the turntable track which allows the ceiling lift to communicate and power the turntable for operation. The powered turntable is operated using the additional buttons on the hand control instead of manually using a pull cord. The hand control buttons are coloured white and black, and they correspond to the direction of the matching-coloured arrows located on the turntable bottom cover. See images below for reference.

To use a ceiling lift with a powered turntable, follow the generic operation guide below:

1. Traverse the ceiling lift into the turntable. (Figure 40)
2. Position the ceiling lift in the centre of the turntable rotating track piece. (Figure 41)
3. Determine the colour of the arrow pointing in the direction you wish to rotate (black or white).
4. Match this colour to the additional buttons located on the handset (black or white).
5. Press and hold the handset button to begin rotating the turntable track. (Figure 41 and 42)
6. Once the rotating track aligns with the desired exiting track, release the handset button.
7. Always ensure that the two track pieces are perfectly aligned to allow the ceiling lift to exit the turntable.

(Adjusting the alignment is only required when there are more than four track exits on the turntable, otherwise the internal end bumpers will automatically stop the turntable rotation and will have aligned the exit for you)

8. Once aligned with the track exit, traverse the ceiling lift out of the turntable and into the new track system. (Figure 43)
9. This process applies to entering and exiting all track systems linked to the powered turntable.

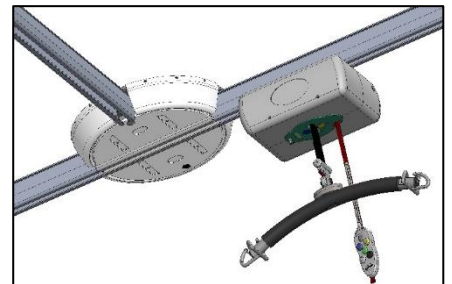

Figure 4-6-2-1

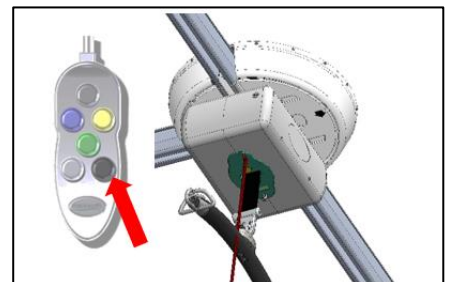

Figure 4-6-2-2

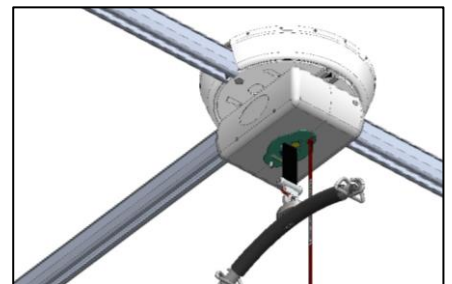

Figure 4-6-2-3

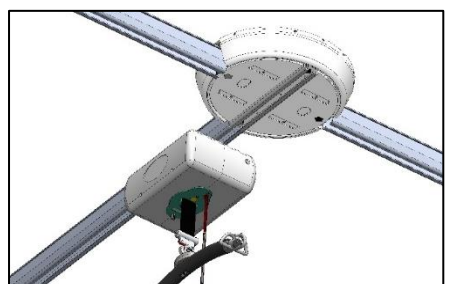

Figure 4-6-2-4

5 Technical Specification

5.1 Ceiling Lift Dimensions

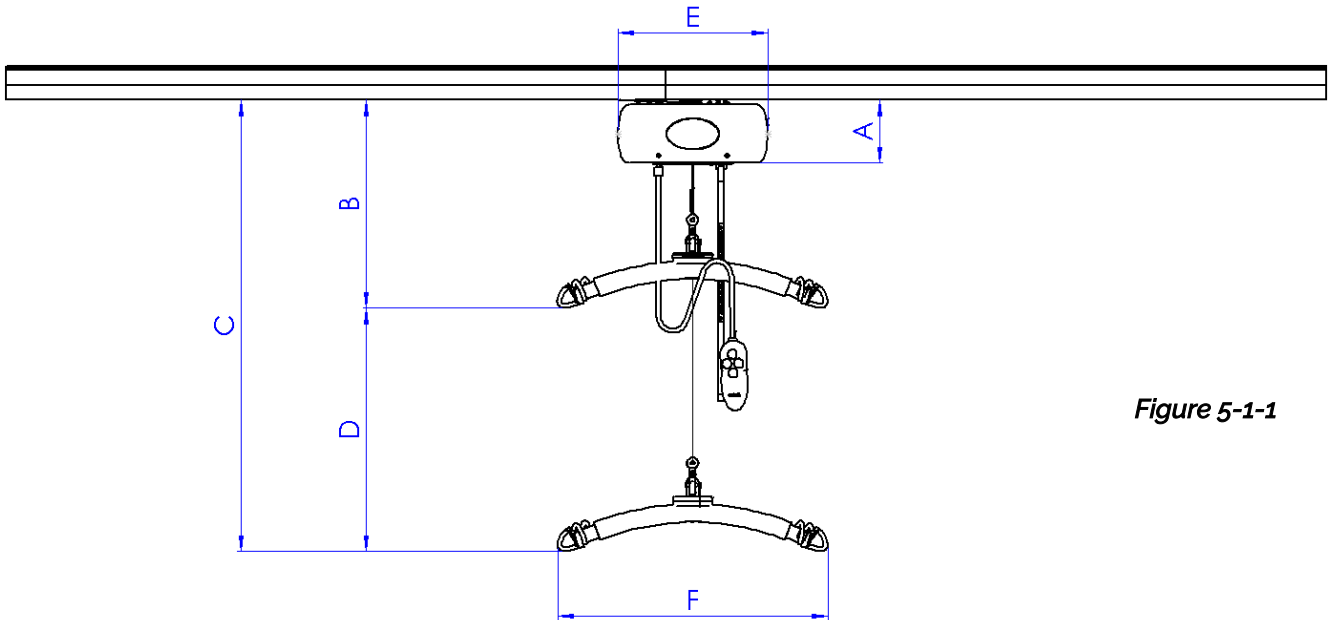

Figure 5-1-1

Ceiling Lift Dimensions - Inches		
Dimensions (Ref to drawing)	Standard Ceiling Lift	QRT Ceiling Lift
A – Track to Ceiling Lift	5.7	7.6
B – Min Distance from Track to Carry Bar	15.6	17.4
C – Max Distance from Track to Carry Bar	94.3	96.1
D – Lifting Range	78.7	78.7
E – Ceiling Lift Width	13.4	13.4
Ceiling Lift Depth	9.8	9.8
F – Carry Bar Width	24.2	24.2

Table 5-1-1

Ceiling Lift Specifications	
Safe Working Loads	
TX Advanced 440	440lb
TX Advanced 600	600lb
Lift Speeds	
Lifting Speed 0lb	2.54"/s
Lifting Speed 291lb	1.44"/s
Lifting Speed 445lb	1.23"/s
Lifting Speed 600lb	1.16"/s
Lowering Speed 0lb	2.23"/s
Lowering Speed 291lb	2.25"/s
Lowering Speed 445lb	2.28"/s
Lowering Speed 600lb	2.14"/s
Battery Specification	
Lead Acid Batteries – x2	24VDC (2x 12VDC) 5.0 AH
Battery Capacity – Raising/Lowering (Top 19.7 inch of Lift Tape) – (291lb)	130 Lifts
Battery Capacity – Raising/Lowering (Top 19.7 inch of Lift Tape) – (445lb)	65 Lifts
Battery Capacity – Raising/Lowering (Top 19.7 inch of Lift Tape) – (600lb)	35 Lifts
Maximum Charging Time	8.5 hrs
Raising/Lowering Duty Cycle	15% use, 85% rest (90 seconds use, 510 seconds rest)
Component Weights	
Ceiling Lift	22lb
Battery charger	1.5lb
Carry bar	4lb
Handset	0.5lb
Operational Forces	
Handset (Pneumatic)	3N
Emergency cord	15N
Hook locking mechanisms on lift tape	2.5N
Spring clips on carry bar	8N
Manually traversing fully loaded ceiling lift (SWL)	50N
Manually traversing unloaded ceiling lift (No weight)	10N
Charger Specification	
Charger Type	In-Track Charging
Charger Input	100-240V AC 50/60Hz 1.5A
Charger Output	24VDC/1.0A
Motor Specification	
Ceiling Lift Motor	24VDC
Drive Motor (if applicable)	24VDC
Ceiling Lift Protection	
Ceiling Lift Case	Flame Retardant ABS
Ceiling Lift Case Degree of Protection	IP21
Handset Degree of Protection	IP67
Sound Level	
Sound Level	54 dB

5.3 LCD and LED Indications

The table below includes the details on all user display messages, it also includes the LED colour, the audible beeping, and instructions on what actions to take when each message appears. This table may help for troubleshooting.

Display Message	Message explanation	LED colour	Beep sound	Instruction
LOW Batt!	Battery Status LOW	Orange	1 Beep Repeat	Place ceiling lift on charge as soon as possible
Charged	Batteries Fully Charged	Green	None	Batteries full - remove from charging dock
Charging	Charging Currently Active	Orange flashing	None	None - Batteries are charging
Up	Ceiling Lift Lifting Active	Green	None	None - Informative only
Down	Ceiling Lift Lowering Active	Green	None	None - Informative only
No Lim_Sw!	Limit Switch Fault	Green	Constant Beep	Contact Service Centre
UP: Inhibit!	Battery Capacity TOO LOW to Lift	Red	3 Beep Repeat	Place ceiling lift on charge immediately
Up Lim_Sw!	Up Limit Switch Active	Green	None	None - Informative only, press Down to continue
Down Lim_Sw!	Down Limit Switch Active	Green	None	None - Informative only, press Up to continue
HIGH CURRENT	High Current Draw from ceiling lift Motor	Green	Beep for 1 Second	Contact Service Centre
PM Due	Preventative Maintenance Due	Green	Beep every 30 minutes	Contact Service Centre

Table 5-3-1

5.4 Standards Applied

The standards that have been applied to the device are as follows:

- IEC 60601-1-1:2012: Medical electrical equipment - Part 1: General requirements for basic safety and essential performance
- IEC 60601-1-2:2014: Medical electrical equipment - Part 1-2: General requirements for basic safety and essential performance - Collateral Standard: Electromagnetic disturbances - Requirements and tests
- IEC 60601-1-11:2010: General requirements for basic safety and essential performance - Collateral Standard: Requirements for medical electrical equipment and medical electrical systems used in the home healthcare environment.
- IEC 62366-1:2015: Medical devices - Part 1: Application of usability engineering to medical devices
- BS EN ISO 14971:2019: Medical devices. Application of risk management to medical devices
- BS EN ISO 12182:2012: Assistive products for persons with disability.
- BS EN ISO 10535:2006: Ceiling Lifts for the transfer of disabled persons. Requirements and test methods
- Medical Device Regulation 2017/745 - CE marking of Medical Devices
- UK Medical Device Regulation 2002: UKCA marking of medical devices.
- EN ISO 15223-1:2016 - Medical devices. Symbols to be used with medical device labels, labelling and information to be supplied. General requirements
- EN 1041:2008+A1:2013 - Information supplied by the manufacturer of medical devices.
- BS ISO 20417 – Medical Devices – Information to be supplied by the manufacture.
- Waste Electrical and Electronic Equipment Directive (WEEE) 2012/19/EU

6 Environmental Conditions

The sections below will give detailed information regarding the environmental conditions the product should maintain throughout its life cycle. Failure to adhere to these conditions may negatively impact the function of the product. If you are unsure of any environmental conditions, always seek advice.

6.1 Operating Environment

The ceiling track lift is intended to be used in dry environments. The ceiling track lift is intended for internal use only.

The ceiling track lift is intended to be used within a professional healthcare facility or home healthcare environment. The ceiling track lift is not suitable for any other environment.

The ceiling track lift is not intended to be used in environments where there are rapid changes in the environmental temperature and humidity.

The ceiling track lift suffers little from any effects of lint, dust, and light.

- Lint – Due to the nature of the ceiling lift being installed closely to the ceiling, very little lint would be likely to gain access into the ceiling lift's workings. The ceiling lift is recommended as per Service Guide to be wiped cleaned during every ceiling lift inspection.
- Dust – Due to the nature of the ceiling lift being installed closely to the ceiling, very little dust would be likely to gain access into the ceiling lift's workings.
- Light – The user controls have been designed to be easily recognisable and the use of bright colours will help the user through all ranges of lighting. The Specification of the ceiling lift dictates that normal use would occur during ambient luminance 50 – 500 lux. Additional as the ceiling lift is designed for indoor use only, if required the user may wish to switch on room lighting. The LCD display on the ceiling lift is backlit to aid with user interaction.

6.1.1 Normal Operating Conditions

+5°C to +40°C (41°F to 104°F) at a relative humidity between 15% to 90% RH, non-condensing but not requiring a water vapour pressure greater than 50hPa and atmospheric pressure between 700hPa to 1060hPa.

6.2 Storage Conditions

The ceiling track lift is intended for internal storage within normal environmental conditions. The ceiling track lift is intended to be stored in a dry room.

It is not intended to be stored in environments where there are rapid changes in the environmental temperature.

When storing the ceiling lift, ensure that the product has been cleaned and dried. For further information, refer to the 'cleaning' section instructions.

6.2.1 Shipping and Storage Conditions

-25°C to +5°C (-13°F to 41°F) with any humidity level.

+5°C to +35°C (41°F to 95°F) at a relative humidity up to 90%.

+35°C to 70°C non-condensing at a water vapour pressure up to 50hPa.

12 Hours are required for the ceiling lift to cool from the maximum storage temperature until ready for its intended use when the ambient temperature is 20°C (68°F).

12 Hours are required for the ceiling lift to warm from the minimum storage temperature until ready for its intended use when the ambient temperature is 20°C (68°F).

7 Daily Checks

Inspection is to be completed prior to each use by the user of the ceiling lift.



Should any of the components in the table below fail the inspection, DO NOT use the ceiling lift. Contact your local authorized dealer for service – contact details are on the last page of this manual.

Ensure all component inspections in the table below are completed prior to each use of the ceiling lift.

Check List before Use:

Component	Service/Inspection required
Generic	Visual inspection of the external of the ceiling lift. Significant damage that may affect the function of the ceiling lift along with a clear safety hazard is unacceptable.
	Check the labelling on the ceiling lift to ensure they are all still legible, this includes the serial number and other important markings. If labels are not legible, then contact your local authorised dealer immediately.
	Check all nuts and bolts that are accessible and visible to see if they are loose, (such as the carry bar hook). If they are not tight or you have concerns, then contact your local authorised dealer immediately.
Emergency Stop Button	Check the emergency stop button functionality.
Carry Bar	Inspect the sling looped attachments for any damage, sharp edges, and excessive wear.
	Check the carry bar rotates and swings freely, and that there is no build-up of wear.
	Ensure the spring clips on the carry bar are functional and present.
Lift Tape	Inspect the lift tape for any signs of damage such as fraying, breaking, and tearing along its entire length. Ensure to also inspect the stitching on the tape for the same signs of damage.
QRS (Quick Release Hook)	Ensure that the locking device on the QRS is closed when the carry bar is attached.
	Inspect the QRS for damage such as cracking. And ensure that the locking device is functioning correctly.
LED's	Ensure that the LED's are all working correctly prior to use.
LCD Display Screen	Ensure that the LCD is working correctly, and the messages can be read.
Wheels	Ensure the wheels are traversing smoothly in the track before traversing a patient along the system. Listen for any unusual noises.
Motor	When raising and lowering the ceiling lift, with or without load, listen to the motor for any unusual lifting noises. Lower the patient immediately if an unusual noise is present.
Handset	Ensure the handset is functional, ensure the connection to the ceiling lift is correct and that all the buttons are working before operation with a patient.

7.1 Lift Tape Caution

The image (Figure 9-1-1) indicates a badly worn lift tape. The ceiling lift should not be used until the lift tape has been replaced. Please contact your local dealer to arrange a service.



It is important to note that an incorrect alignment of the lift tape with the hoist could lead to tape fraying, causing delays in the hoist operation and additional expenses. For a smooth and safe operation, please ensure the lift tape is vertically in line with the hoist, when lowering or raising the carry bar.



Figure 7-1-1

8 Cleaning



To reduce the risk of cross-contamination it is recommended to clean the ceiling track lift and accessories before use by a different person.

Please follow the recommended cleaning guidelines below on cleaning and disinfecting the ceiling track lift.

8.1 Ceiling Lift Cover Cleaning

For cleaning, the covers can be cleaned using a damp cloth, soap/water, and antibacterial spray. Do not use a steam cleaner as this could damage the internals of the ceiling lift as well as label integrity. Do not use industrial bleaches, abrasive cleaners, or organic solvents.

All cleaning solutions must be thoroughly rinsed off the product at the end of the cleaning process and the product dried using a dry cloth/towel. Always ensure the product is dry before use.



Care should always be taken when cleaning around electrical components to reduce the risk of electric shock or damage to the Ceiling lift.

8.2 Lift Tape Cleaning

Lift tapes can be wiped down using a dry cloth to remove any mild dirt and dust. When a spillage occurs, it is recommended that it be cleaned as quickly as possible to avoid any staining; it is good practice to dab the spillage and not to rub it as this could cause staining. For more persistent stains and dirt, hot water with an antibacterial spray can also be used.

All cleaning solutions must be thoroughly rinsed off the product at the end of the cleaning process and dried using a dry cloth/towel. Always ensure the product is dry before use.

8.3 Disinfecting

Should the ceiling lift require a more thorough cleaning, the use of the Actichlor™ disinfectant product (which is widely available in tablet form and used throughout the healthcare industry) is recommended.



Follow the manufacturer's safety instructions for the use of this cleaning product before use to ensure safe use for the operator and the user.
Ensure the cloth is damp before the cleaning process.

Application is through a clean damp cloth applied to wipe the product down. Use in the following dilutions to ensure an effective clean:

- Actichlor™ dissolvable chlorine tablets provide a concentration of 1000 ppm of available chlorine (0.1%) per 1 tablet.
- 1 tablet (1.7g formed tablet (x1)) will create a virucidal solution, diluted in 1 litre of water to provide effective means to clean a "dirty" product. This is also ideal for use after an outbreak of the Norovirus/winter vomiting and can be used as a precaution against C.Diff. It is effective against viruses, bacteria, spores, yeasts, and moulds.
- A minimum of 5 minutes contact time with the outer components is recommended to prevent virucidal infections, whilst maintaining the integrity of the product. The product can withstand a longer contact period, however a minimum of 5 minutes is required to provide an effective cleaning regime.
- Blood spills should be dealt with by an increased concentration of the solution – please refer to the instructions on the manufacturer's product labelling.

Dilution chart					
Product used as	Product condition	Concentration (ppm)	Dilution qty* (l)	Tablets per 1l (0.26gal)	Contact time (minutes)
Bactericidal	Clean	200	5 (1.32gal)	1	1
	Dirty	1000	1 (0.26gal)	1	5
Yeasticidal	Clean	200	5 (1.32gal)	1	1
	Dirty	1000	1 (0.26gal)	1	5
Fungicidal	Clean	2000	1 (0.26gal)	2	15
	Dirty	5000	1 (0.26gal)	5	15
Mycrobactericidal	Clean	1000	1 (0.26gal)	1	15
	Dirty	5000	1 (0.26gal)	5	15
Virucidal	Clean	500	2 (0.53gal)	1	5
	Dirty	1000	1 (0.26gal)	1	5
Sporcidal (C. Diff)	Clean	1000	1 (0.26gal)	1	10
	-	-	-	-	-
Sporcidal	Clean	5000	1 (0.26gal)	5	10
	-	-	-	-	-

- Dilution is made with water. DO NOT dilute within any other medium.
- When diluted in water, one tablet gives 1000ppm of available chlorine.
- The concentration of the solution depends upon whether the object being cleaned is noticeably dirty (indicated in the table by "Product condition").

Table 8-3-1

Handling and storage safety precautions when using this cleaning agent:		
Advice on Safe Handling	Hygiene Measures	Conditions for Safe Storage
<p>Avoid contact with skin and eyes.</p> <p>Do not breathe dust, fumes, gas, mist, vapours, spray.</p> <p>Use only with adequate ventilation.</p> <p>Wash hands thoroughly after handling.</p> <p>Mixing this product with acid or ammonia releases chlorine gas.</p>	<p>Handle in accordance with good industrial hygiene and safety practice.</p> <p>Remove and wash contaminated clothing before re-use.</p> <p>Wash face, hands, and any exposed skin thoroughly after handling.</p>	<p>Keep out of reach of children.</p> <p>Keep container tightly closed.</p> <p>Store in suitable labelled containers.</p> <p>Storage temperature: 0-25°C (32-77°F).</p>
Individual Protective Measures	Dissolve	
Hand protection: Gloves	Dissolve in cold water – With no agitation, 1 tablet will take approximately 10 minutes to fully dissolve in the water used.	
<p>The information above has been extracted from the Actichlor™ MSDS (Manufacturers Safety Data Sheet). For a full review of the data please follow the link below:</p> <p>http://www.nhsggc.org.uk/media/236215/msds-actichlor-plus.pdf</p>		

Table 8-3-2

9 Servicing

Regular servicing on the ceiling track lift will help prevent breakdowns and reduce repair costs. It will also improve the quality of the product for the end users.



To reduce the risk of injury, no service is to be carried out on the ceiling lift while in use. Service must be completed by an authorised service engineer only. Do not attempt to service the product yourself; this will void your warranty.

To ensure the safety and continued good function of your ceiling track ceiling lift, it is recommended to have an approved service engineer perform a routine service every 6 months, this will ensure that the product meets the required standards. It is important to document the service history of the product in the service log located at the back of this user manual after each service.

When the product is serviced, the service checklist must be completed.
Service Manual Document Number: 995174.

For information regarding spare parts, refer to the spare parts manual.
Spare Parts Manual Document Number: 992174.

Contact your local authorised dealer if you:

- Need more information.
- Have any questions about the use or service of your product.
- Notice any change in the performance.
- Want to report an unexpected occurrence.
- Want to arrange a service.
- Need to ascertain necessary information for replacement parts and components.

The expected product lifetime is **10 years**. This is dependent on usage and compliance with maintenance, servicing and LOLER inspections. Regular service on the product will increase the expected lifetime.

Serviceable parts within this period are batteries and the lift tape. Batteries should have an expected service life of 200 discharge cycles or 3 years, dependant on the charging routine. The lift tape should have an expected service life of 2 years if used correctly but visual inspection should be carried out before use.

10 Troubleshooting

Should a problem arise with the use of the ceiling lift, review the table below. Find the fault and complete the recommended solution. If the fault is not listed below or the solution does not correct the problem, contact your local authorised dealer immediately – contact details are provided on the last page of this manual.

Fault	Action
The handset has become disengaged from the ceiling lift, or the Handset buttons are not responding.	Refer to the section 'Applied Parts'. If this does not correct the fault, then contact your local authorised dealer immediately so the ceiling lift can be checked to ensure proper continued operation.
The handset button command is continuously activated – UP, DOWN, E-LOWER.	Turn off the ceiling lift using the red pull cord. Contact your local authorised dealer immediately so that the ceiling lift can be checked to ensure proper continued operation.
No Power Part 1	If the emergency red cord has been used to either stop or lower the person, the ceiling lift will not operate again until it has been reset. Contact your local authorised dealer immediately so that the ceiling lift can be checked that it is safe to reset.
No Power Part 2	Operate the hand control to determine if the ceiling lift wakes up. This can be determined from the green LED. If not present, the ceiling lift may be out of charge. Place ceiling lift into the charging dock for a minimum of one hour to determine if this resolves the issue. If not, contact your local authorised dealer.
The ceiling lift LEDs indicate there is power, but the ceiling lift does not operate in the DOWN direction.	A built-in detector checks the slackness of the lift tape. This may be sensitive. Apply weight to the carry bar while pressing the DOWN button at the same time. If this corrects the fault temporarily but not permanently then contact your local authorised dealer so that the ceiling lift can be checked to ensure proper continued operation
The red indicator light on the ceiling lift turns RED and/or a loud alarm sound is heard when an individual is raised.	The batteries are low and require charging. Refer to section 'Charging the Ceiling Lift' and charge the for at least one hour before trying to raise/lower the carry bar. If this does not correct the fault, then contact your local authorised dealer immediately so that the ceiling lift can be checked to ensure proper continued operation.
The ceiling lift does not pass through a track component such as a turntable or gate.	Refer to the user manual of the specific piece of equipment in question. If the recommended solution does not correct the fault, then contact your local authorised dealer immediately so that the track component and ceiling lift can be checked to ensure proper continued operation.
Intermittent Display Screen – Self Recovering	If the display screen goes blank but self recovers, there is an electromagnetic disturbance in the vicinity, if the ceiling lift remains operational, continue to use, and investigate the source of the disturbance.
Display Screen goes blank but LED functions	This may be caused by an electromagnetic disturbance, if the ceiling lift remains operational, continue to use, and investigate the source of the disturbance.
Intermittent Motor performance	This may be caused by an electromagnetic disturbance, if the ceiling lift remains operational, continue to use, and investigate the source of the disturbance. When the motor performance is compromised, contact your local service provider.

Table 12-1-1

11 Disposal

With efforts to improve the environment and reduce waste, where possible our products have been manufactured with recyclable materials. Below are our guidelines on recyclable materials and being environmentally friendly.

The ceiling lift should be disposed by an approved service engineer at the end of its life cycle. For guidelines on correct decommissioning procedures, refer to the commissioning guide: 996674.

Please observe the local laws on recycling and respect the current laws for disposal within the community the product is being used within. If there is any uncertainty of the below guidelines, contact your local authorities to determine the proper method of disposal of potentially biohazardous parts and accessories.

Fully recyclables:	Consideration when Recycling:
Chassis	Batteries
Plastic Covers	Wiring Looms – electronics
Metallic Internals – Hub etc.	PCB
Initial packaging of the device (cardboard)	Hand Control
Metallic fixing – Screws etc.	Motors
Plastic Mouldings	Lift Tape
Carry Bar	Charger

Table 11-1



The product may be contaminated and must be disinfected before recycling or disposal. See section on 'Cleaning' for further details.

12 Warranty

It is impossible for all the risks to be eliminated from use of this product, but to reduce risk and improve safe and proper use, the user should always read and understand the user manual before use. Product failure may occur due to lack of maintenance and care, misuse, unauthorised and improper servicing or alterations, improper storage, and environmental use, or through normal use wear and tear. These factors are all beyond the control from the manufacturer. These risks are taken on by the users.

The ceiling lift comes with a 1-year warranty covering all manufacture defects. Refer to your terms and conditions for more detailed information. The warranty is valid if the product has maintained its intended use and the user manual instructions have been followed. The warranty will not extend to the use of the product when used contrary to the user manual. This guarantee does not affect or in any way limit your statutory rights.

1. The liability of the manufacturer under the terms of this guarantee shall be limited to the replacement of the defective part(s) to the sales distributor, dealer, agent, person, or entity which purchased the equipment from the manufacturer. In no event shall the manufacturer incur liability for any consequential or unforeseeable losses.
2. This equipment guarantee shall be void if the equipment is not serviced by an authorised service engineer, in accordance with the manufacturer's recommendations, or if any unauthorised persons carry out work on the equipment.
3. This guarantee does not apply to failure attributable to normal wear and tear, damage by natural forces, user neglect or misuse or deliberate destruction.
4. Do not attempt to service the product yourself, or the warranty is void.

13 Service Record History

Complete this section after each service, repair inspection and/or maintenance.

Date:	Time:
Service Type: Service Inspection <input type="checkbox"/> Repair <input type="checkbox"/> Other <input type="checkbox"/>	
Completed By: (Printed name) (Signature)	
Company:	
Remarks & Actions Taken:	
Product Left in A Safe & Usable Condition: Yes <input type="checkbox"/> No <input type="checkbox"/> (if no explain in actions above)	
Date:	Time:
Service Type: Service Inspection <input type="checkbox"/> Repair <input type="checkbox"/> Other <input type="checkbox"/>	
Completed By: (Printed name) (Signature)	
Company:	
Remarks & Actions Taken:	
Product Left in A Safe & Usable Condition: Yes <input type="checkbox"/> No <input type="checkbox"/> (if no explain in actions above)	
Date:	Time:
Service Type: Service Inspection <input type="checkbox"/> Repair <input type="checkbox"/> Other <input type="checkbox"/>	
Completed By: (Printed name) (Signature)	
Company:	
Remarks & Actions Taken:	
Product Left in A Safe & Usable Condition: Yes <input type="checkbox"/> No <input type="checkbox"/> (if no explain in actions above)	
Date:	Time:
Service Type: Service Inspection <input type="checkbox"/> Repair <input type="checkbox"/> Other <input type="checkbox"/>	
Completed By: (Printed name) (Signature)	
Company:	
Remarks & Actions Taken:	
Product Left in A Safe & Usable Condition: Yes <input type="checkbox"/> No <input type="checkbox"/> (if no explain in actions above)	
Date:	Time:
Service Type: Service Inspection <input type="checkbox"/> Repair <input type="checkbox"/> Other <input type="checkbox"/>	
Completed By: (Printed name) (Signature)	
Company:	
Remarks & Actions Taken:	
Product Left in A Safe & Usable Condition: Yes <input type="checkbox"/> No <input type="checkbox"/> (if no explain in actions above)	

Date:	Time:
Service Type: Service Inspection <input type="checkbox"/> Repair <input type="checkbox"/> Other <input type="checkbox"/>	
Completed By: (Printed name) (Signature)	
Company:	
Remarks & Actions Taken:	
Product Left in A Safe & Usable Condition: Yes <input type="checkbox"/> No <input type="checkbox"/> (if no explain in actions above)	
Date:	Time:
Service Type: Service Inspection <input type="checkbox"/> Repair <input type="checkbox"/> Other <input type="checkbox"/>	
Completed By: (Printed name) (Signature)	
Company:	
Remarks & Actions Taken:	
Product Left in A Safe & Usable Condition: Yes <input type="checkbox"/> No <input type="checkbox"/> (if no explain in actions above)	
Date:	Time:
Service Type: Service Inspection <input type="checkbox"/> Repair <input type="checkbox"/> Other <input type="checkbox"/>	
Completed By: (Printed name) (Signature)	
Company:	
Remarks & Actions Taken:	
Product Left in A Safe & Usable Condition: Yes <input type="checkbox"/> No <input type="checkbox"/> (if no explain in actions above)	
Date:	Time:
Service Type: Service Inspection <input type="checkbox"/> Repair <input type="checkbox"/> Other <input type="checkbox"/>	
Completed By: (Printed name) (Signature)	
Company:	
Remarks & Actions Taken:	
Product Left in A Safe & Usable Condition: Yes <input type="checkbox"/> No <input type="checkbox"/> (if no explain in actions above)	
Date:	Time:
Service Type: Service Inspection <input type="checkbox"/> Repair <input type="checkbox"/> Other <input type="checkbox"/>	
Completed By: (Printed name) (Signature)	
Company:	
Remarks & Actions Taken:	
Product Left in A Safe & Usable Condition: Yes <input type="checkbox"/> No <input type="checkbox"/> (if no explain in actions above)	

Date:	Time:
Service Type: Service Inspection <input type="checkbox"/> Repair <input type="checkbox"/> Other <input type="checkbox"/>	
Completed By: (Printed name) (Signature)	
Company:	
Remarks & Actions Taken:	
Product Left in A Safe & Usable Condition: Yes <input type="checkbox"/> No <input type="checkbox"/> (if no explain in actions above)	
Date:	Time:
Service Type: Service Inspection <input type="checkbox"/> Repair <input type="checkbox"/> Other <input type="checkbox"/>	
Completed By: (Printed name) (Signature)	
Company:	
Remarks & Actions Taken:	
Product Left in A Safe & Usable Condition: Yes <input type="checkbox"/> No <input type="checkbox"/> (if no explain in actions above)	
Date:	Time:
Service Type: Service Inspection <input type="checkbox"/> Repair <input type="checkbox"/> Other <input type="checkbox"/>	
Completed By: (Printed name) (Signature)	
Company:	
Remarks & Actions Taken:	
Product Left in A Safe & Usable Condition: Yes <input type="checkbox"/> No <input type="checkbox"/> (if no explain in actions above)	
Date:	Time:
Service Type: Service Inspection <input type="checkbox"/> Repair <input type="checkbox"/> Other <input type="checkbox"/>	
Completed By: (Printed name) (Signature)	
Company:	
Remarks & Actions Taken:	
Product Left in A Safe & Usable Condition: Yes <input type="checkbox"/> No <input type="checkbox"/> (if no explain in actions above)	
Date:	Time:
Service Type: Service Inspection <input type="checkbox"/> Repair <input type="checkbox"/> Other <input type="checkbox"/>	
Completed By: (Printed name) (Signature)	
Company:	
Remarks & Actions Taken:	
Product Left in A Safe & Usable Condition: Yes <input type="checkbox"/> No <input type="checkbox"/> (if no explain in actions above)	

Date:	Time:
Service Type: Service Inspection <input type="checkbox"/> Repair <input type="checkbox"/> Other <input type="checkbox"/>	
Completed By: (Printed name) (Signature)	
Company:	
Remarks & Actions Taken:	
Product Left in A Safe & Usable Condition: Yes <input type="checkbox"/> No <input type="checkbox"/> (if no explain in actions above)	
Date:	Time:
Service Type: Service Inspection <input type="checkbox"/> Repair <input type="checkbox"/> Other <input type="checkbox"/>	
Completed By: (Printed name) (Signature)	
Company:	
Remarks & Actions Taken:	
Product Left in A Safe & Usable Condition: Yes <input type="checkbox"/> No <input type="checkbox"/> (if no explain in actions above)	
Date:	Time:
Service Type: Service Inspection <input type="checkbox"/> Repair <input type="checkbox"/> Other <input type="checkbox"/>	
Completed By: (Printed name) (Signature)	
Company:	
Remarks & Actions Taken:	
Product Left in A Safe & Usable Condition: Yes <input type="checkbox"/> No <input type="checkbox"/> (if no explain in actions above)	
Date:	Time:
Service Type: Service Inspection <input type="checkbox"/> Repair <input type="checkbox"/> Other <input type="checkbox"/>	
Completed By: (Printed name) (Signature)	
Company:	
Remarks & Actions Taken:	
Product Left in A Safe & Usable Condition: Yes <input type="checkbox"/> No <input type="checkbox"/> (if no explain in actions above)	
Date:	Time:
Service Type: Service Inspection <input type="checkbox"/> Repair <input type="checkbox"/> Other <input type="checkbox"/>	
Completed By: (Printed name) (Signature)	
Company:	
Remarks & Actions Taken:	
Product Left in A Safe & Usable Condition: Yes <input type="checkbox"/> No <input type="checkbox"/> (if no explain in actions above)	

Date:	Time:
Service Type: Service Inspection <input type="checkbox"/> Repair <input type="checkbox"/> Other <input type="checkbox"/>	
Completed By: (Printed name) (Signature)	
Company:	
Remarks & Actions Taken:	
Product Left in A Safe & Usable Condition: Yes <input type="checkbox"/> No <input type="checkbox"/> (if no explain in actions above)	
Date:	Time:
Service Type: Service Inspection <input type="checkbox"/> Repair <input type="checkbox"/> Other <input type="checkbox"/>	
Completed By: (Printed name) (Signature)	
Company:	
Remarks & Actions Taken:	
Product Left in A Safe & Usable Condition: Yes <input type="checkbox"/> No <input type="checkbox"/> (if no explain in actions above)	
Date:	Time:
Service Type: Service Inspection <input type="checkbox"/> Repair <input type="checkbox"/> Other <input type="checkbox"/>	
Completed By: (Printed name) (Signature)	
Company:	
Remarks & Actions Taken:	
Product Left in A Safe & Usable Condition: Yes <input type="checkbox"/> No <input type="checkbox"/> (if no explain in actions above)	
Date:	Time:
Service Type: Service Inspection <input type="checkbox"/> Repair <input type="checkbox"/> Other <input type="checkbox"/>	
Completed By: (Printed name) (Signature)	
Company:	
Remarks & Actions Taken:	
Product Left in A Safe & Usable Condition: Yes <input type="checkbox"/> No <input type="checkbox"/> (if no explain in actions above)	
Date:	Time:
Service Type: Service Inspection <input type="checkbox"/> Repair <input type="checkbox"/> Other <input type="checkbox"/>	
Completed By: (Printed name) (Signature)	
Company:	
Remarks & Actions Taken:	
Product Left in A Safe & Usable Condition: Yes <input type="checkbox"/> No <input type="checkbox"/> (if no explain in actions above)	

Date:	Time:
Service Type: Service Inspection <input type="checkbox"/> Repair <input type="checkbox"/> Other <input type="checkbox"/>	
Completed By: (Printed name) (Signature)	
Company:	
Remarks & Actions Taken:	
Product Left in A Safe & Usable Condition: Yes <input type="checkbox"/> No <input type="checkbox"/> (if no explain in actions above)	
Date:	Time:
Service Type: Service Inspection <input type="checkbox"/> Repair <input type="checkbox"/> Other <input type="checkbox"/>	
Completed By: (Printed name) (Signature)	
Company:	
Remarks & Actions Taken:	
Product Left in A Safe & Usable Condition: Yes <input type="checkbox"/> No <input type="checkbox"/> (if no explain in actions above)	
Date:	Time:
Service Type: Service Inspection <input type="checkbox"/> Repair <input type="checkbox"/> Other <input type="checkbox"/>	
Completed By: (Printed name) (Signature)	
Company:	
Remarks & Actions Taken:	
Product Left in A Safe & Usable Condition: Yes <input type="checkbox"/> No <input type="checkbox"/> (if no explain in actions above)	
Date:	Time:
Service Type: Service Inspection <input type="checkbox"/> Repair <input type="checkbox"/> Other <input type="checkbox"/>	
Completed By: (Printed name) (Signature)	
Company:	
Remarks & Actions Taken:	
Product Left in A Safe & Usable Condition: Yes <input type="checkbox"/> No <input type="checkbox"/> (if no explain in actions above)	
Date:	Time:
Service Type: Service Inspection <input type="checkbox"/> Repair <input type="checkbox"/> Other <input type="checkbox"/>	
Completed By: (Printed name) (Signature)	
Company:	
Remarks & Actions Taken:	
Product Left in A Safe & Usable Condition: Yes <input type="checkbox"/> No <input type="checkbox"/> (if no explain in actions above)	

Date:	Time:
Service Type: Service Inspection <input type="checkbox"/> Repair <input type="checkbox"/> Other <input type="checkbox"/>	
Completed By: (Printed name) (Signature)	
Company:	
Remarks & Actions Taken:	
Product Left in A Safe & Usable Condition: Yes <input type="checkbox"/> No <input type="checkbox"/> (if no explain in actions above)	
Date:	Time:
Service Type: Service Inspection <input type="checkbox"/> Repair <input type="checkbox"/> Other <input type="checkbox"/>	
Completed By: (Printed name) (Signature)	
Company:	
Remarks & Actions Taken:	
Product Left in A Safe & Usable Condition: Yes <input type="checkbox"/> No <input type="checkbox"/> (if no explain in actions above)	
Date:	Time:
Service Type: Service Inspection <input type="checkbox"/> Repair <input type="checkbox"/> Other <input type="checkbox"/>	
Completed By: (Printed name) (Signature)	
Company:	
Remarks & Actions Taken:	
Product Left in A Safe & Usable Condition: Yes <input type="checkbox"/> No <input type="checkbox"/> (if no explain in actions above)	
Date:	Time:
Service Type: Service Inspection <input type="checkbox"/> Repair <input type="checkbox"/> Other <input type="checkbox"/>	
Completed By: (Printed name) (Signature)	
Company:	
Remarks & Actions Taken:	
Product Left in A Safe & Usable Condition: Yes <input type="checkbox"/> No <input type="checkbox"/> (if no explain in actions above)	
Date:	Time:
Service Type: Service Inspection <input type="checkbox"/> Repair <input type="checkbox"/> Other <input type="checkbox"/>	
Completed By: (Printed name) (Signature)	
Company:	
Remarks & Actions Taken:	
Product Left in A Safe & Usable Condition: Yes <input type="checkbox"/> No <input type="checkbox"/> (if no explain in actions above)	

Date:	Time:
Service Type: Service Inspection <input type="checkbox"/> Repair <input type="checkbox"/> Other <input type="checkbox"/>	
Completed By: (Printed name) (Signature)	
Company:	
Remarks & Actions Taken:	
Product Left in A Safe & Usable Condition: Yes <input type="checkbox"/> No <input type="checkbox"/> (if no explain in actions above)	
Date:	Time:
Service Type: Service Inspection <input type="checkbox"/> Repair <input type="checkbox"/> Other <input type="checkbox"/>	
Completed By: (Printed name) (Signature)	
Company:	
Remarks & Actions Taken:	
Product Left in A Safe & Usable Condition: Yes <input type="checkbox"/> No <input type="checkbox"/> (if no explain in actions above)	
Date:	Time:
Service Type: Service Inspection <input type="checkbox"/> Repair <input type="checkbox"/> Other <input type="checkbox"/>	
Completed By: (Printed name) (Signature)	
Company:	
Remarks & Actions Taken:	
Product Left in A Safe & Usable Condition: Yes <input type="checkbox"/> No <input type="checkbox"/> (if no explain in actions above)	
Date:	Time:
Service Type: Service Inspection <input type="checkbox"/> Repair <input type="checkbox"/> Other <input type="checkbox"/>	
Completed By: (Printed name) (Signature)	
Company:	
Remarks & Actions Taken:	
Product Left in A Safe & Usable Condition: Yes <input type="checkbox"/> No <input type="checkbox"/> (if no explain in actions above)	
Date:	Time:
Service Type: Service Inspection <input type="checkbox"/> Repair <input type="checkbox"/> Other <input type="checkbox"/>	
Completed By: (Printed name) (Signature)	
Company:	
Remarks & Actions Taken:	
Product Left in A Safe & Usable Condition: Yes <input type="checkbox"/> No <input type="checkbox"/> (if no explain in actions above)	

Dealer/service contact details:

Contact details:

Mackworth USA
54 West Industrial Drive
O'Fallon, MO 63366 USA
314-889-1000
www.mackworthusa.com

Disclaimer

While every effort has been made to ensure the accuracy of information contained in this manual, no liability can be accepted by Mackworth for any errors or omissions. Mackworth operates a policy of continuous improvement. Specifications and other data are subject to change without notice.



mackworth

54 West Industrial Drive
O'Fallon, MO 63366 USA

