

Lift Motor Testing Guide

Covering All Transactive Xtra Models

This document will guide you on how to determine a fault between the PCB, toggle switch and lift motor of the ceiling lift. Follow the steps below to determine if the components are functioning correctly.

The diagram below shows each connection port found on the PCB and what component plugs into each port. Ensure that each port is plugged in (where applicable). (Limit Switch Block looks different on the transactive model but the connections are the same).

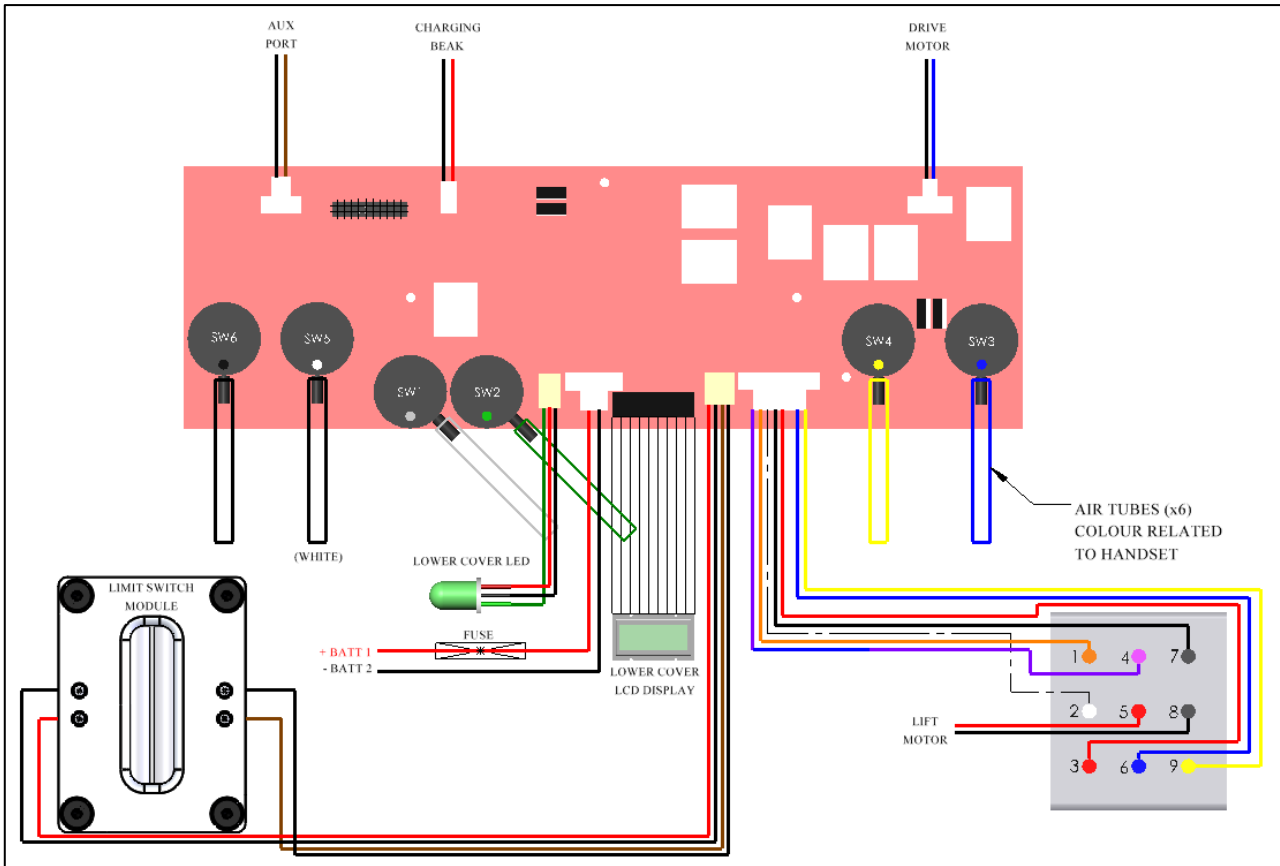

Each of the below troubleshooting guides requires a multi-meter to test power inputs and outputs from the board. Prepare the multi-meter by setting it to read DC volts, the red lead (positive) should be plugged into the voltage port, and the black lead (negative) should be plugged into the COM port. The display screen should show a reading of 0.0 volts.



Is the lift motor receiving power from the toggle switch?

Step 1

Determine the location of the toggle switch to motor connection leads, these are mounted onto the inside of the cover.

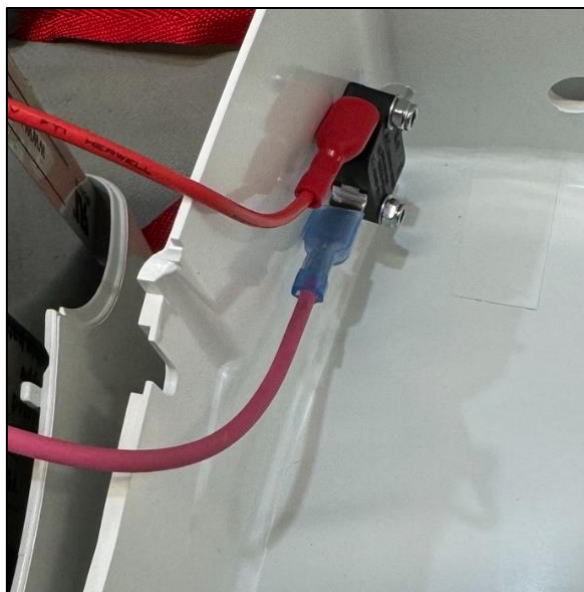

Step 2

Ensure that the batteries are charged, the LCD display will show the current battery status. For best results, fully charge the batteries prior to testing.

Step 3

Ensure that the toggle switch is in its 'ON' state.

Step 4

Disconnect the connectors to access the toggle switch connection points.



Step 5

To determine if the voltage is running through the toggle switch cables. Touch the black (negative) lead onto the black wire terminal, and the red (positive) lead onto the red wire terminal. (See image for reference).

To test function, you must activate the lift function by pressing and holding the up or down button on the handset. This should display between **18 and 26v**.

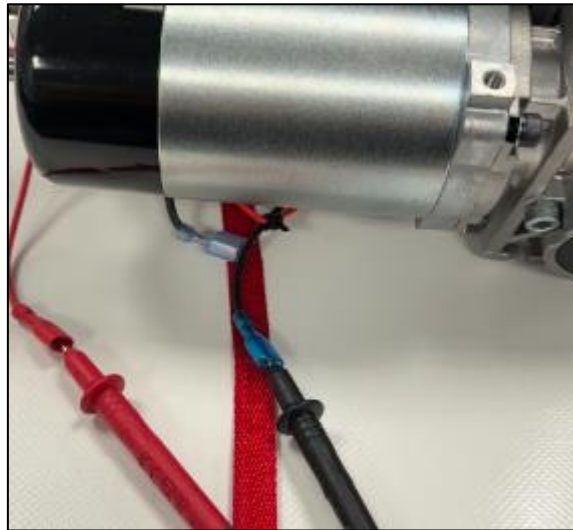

If it is not receiving at least **18v**, then there is a fault with the PCB or Toggle Switch, follow 'is the toggle switch receiving power' testing guide.

If the connectors are reading the correct voltage, then there is a fault with the lift motor. Follow 'lift motor not working' guide.

Test Complete

Is the toggle switch receiving power?

Step 1

Determine the location of the toggle switch port, this is located at the bottom right of the board, to the right of the limit switch port.

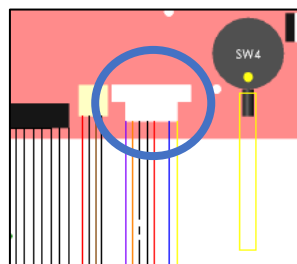

Step 2

Ensure that the batteries are charged, the LCD display will show the current battery status. For best results, fully charge the batteries prior to testing.

Step 3

Disconnect the toggle switch cable from the port.

Step 4

To determine if the voltage is running through the port. Touch the black (negative) lead onto the orange wire terminal (first terminal, bottom row), and the red (positive) lead onto the white wire terminal (second terminal, first row). (See image for reference). This should display between **18 and 25.5v**.

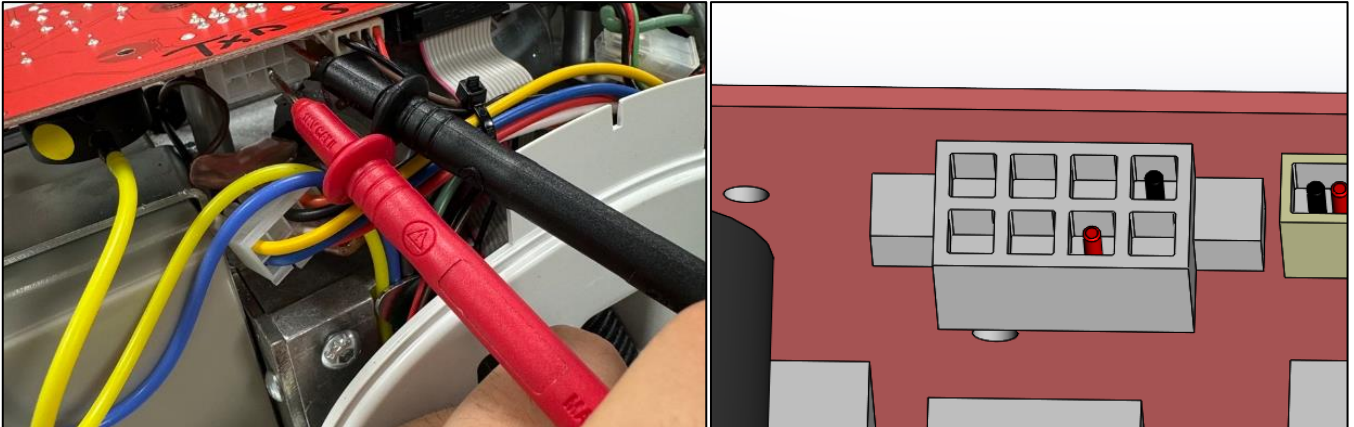

If the toggle switch port is not receiving at least **18v**, then there is a fault in the board. The board must be replaced.

Step 5

If the toggle switch port is receiving the correct voltage, test the e-lower function is working. If the e-lower function is not working, then there is a fault with the toggle switch. The toggle switch must be replaced.

Step 6

If the e-lower function is not working, the power back into the board from the toggle switch can be tested to diagnose the issue.

To determine if the voltage is running through the port. Touch the black (negative) lead onto the black wire terminal (second terminal, bottom row), and the red (positive) lead onto the red wire terminal (third terminal, top row). (See image for reference). This should display between **18 and 26v**.

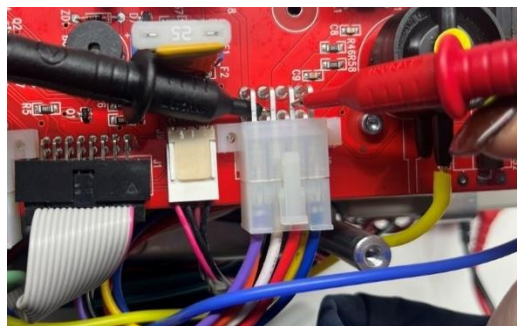

If the toggle switch port is not receiving at least **18v**, then there is a fault with the toggle switch. The toggle switch must be replaced.

if the toggle switch port is receiving the correct voltage, then there is a fault with the board. The board must be replaced.

Test Complete

Lift Motor not working?

Step 1

This section should only be completed following 'Is the lift motor receiving power from the toggle switch?' guide.

Step 2

The only repair to the lift motor we recommend is refitting the brushes inside. When the ceiling lift has been impacted during transport or any form of sudden shock has occurred. It has been known for the brushes inside the lift motor to disengage, causing the lift motor to lose function.

If the brushes have not disengaged. No further lift motor repairs can be done. The motor must be replaced.

Step 3

To repair, remove the lift motor from the ceiling lift, follow the servicing guide for the correct removal process.

Step 4

Remove the lift motor cap using a using a pozi screwdriver on the two pozi-pan screws.

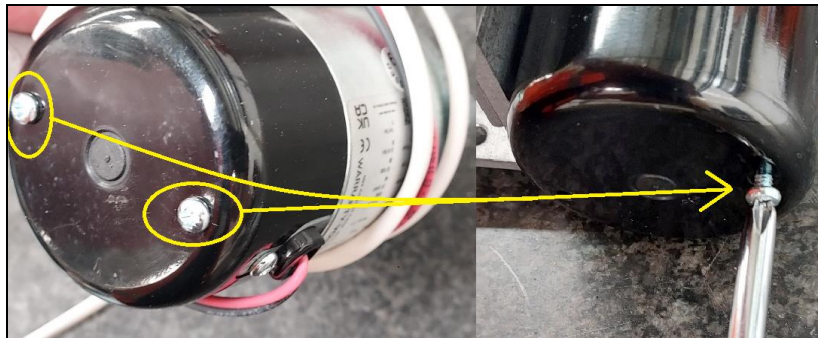

Inspect the lift motor brushes, they should be held in place by a spring as shown below. If the brushes have popped out (as shown), reposition the brushes in place and secure with the spring. There are two brushes inside the motor. Make sure both are refitted correctly.

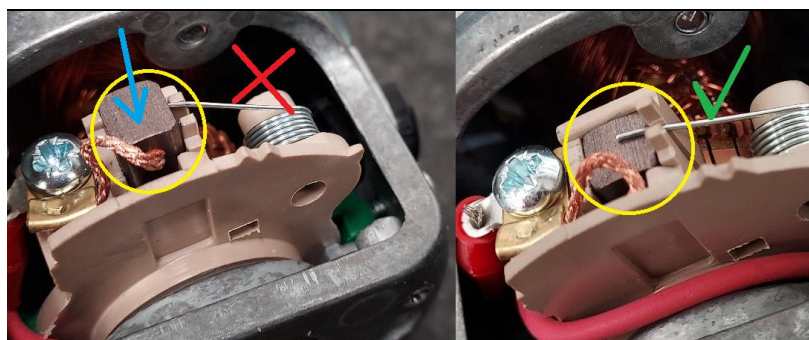

Once the brushes are positioned back in place. Secure the lift motor cap back in place with the pozi-pan screws.

Step 5

Test the function of the lift motor on the ceiling lift. If the lift motor is still not working, a replacement is required.

Test Complete