

Transactive Xtra Ceiling Track Hoist



Spare Parts Manual



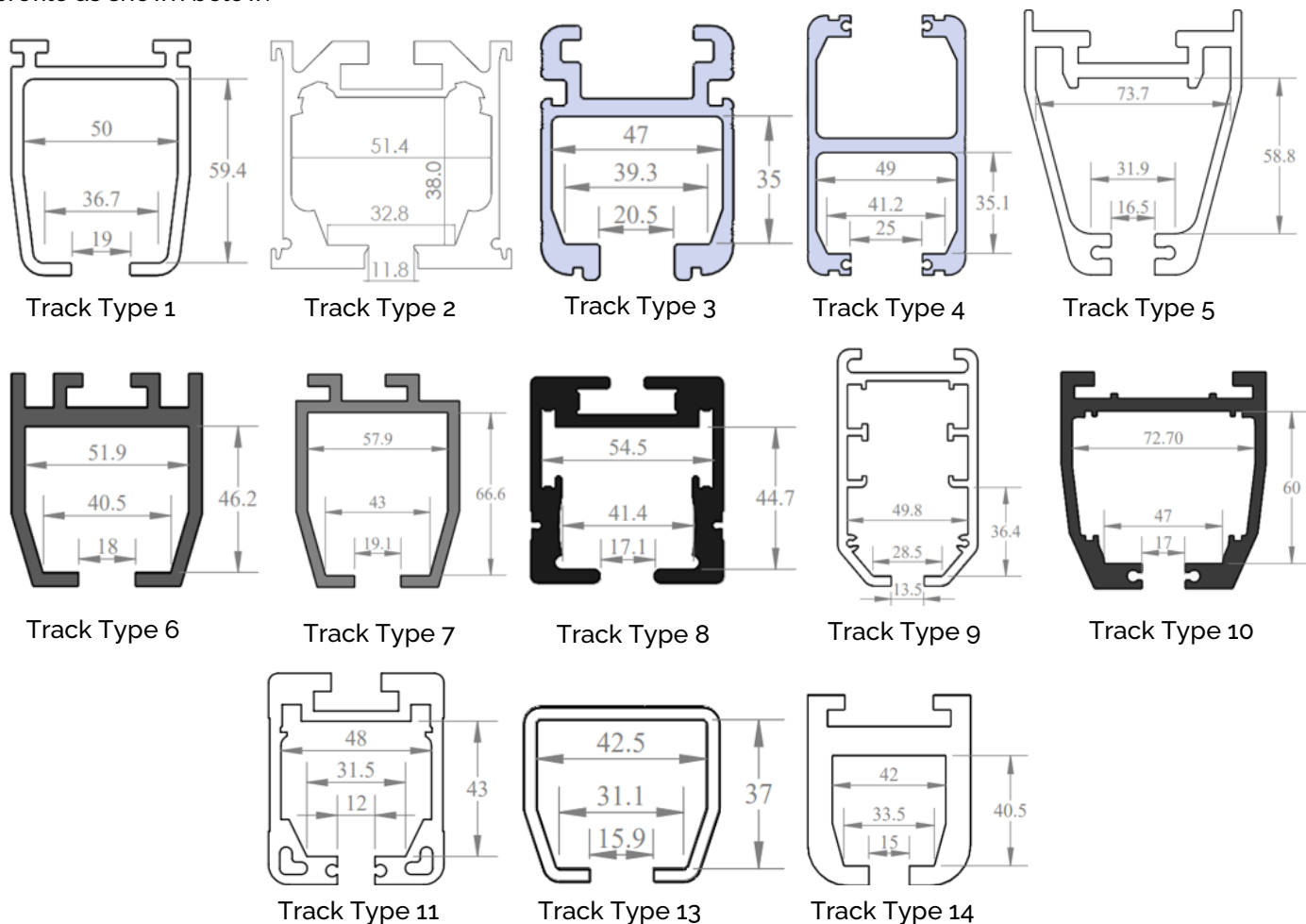

1 Spare Parts



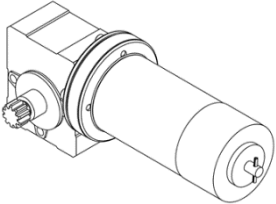
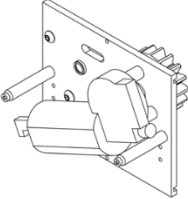

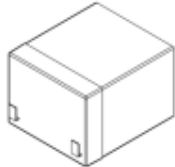
The parts listed in this manual are for the Freeway Transactive Xtra, this hoist is only compatible with the track profile as shown below:

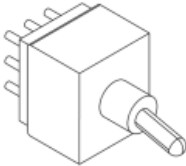
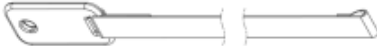
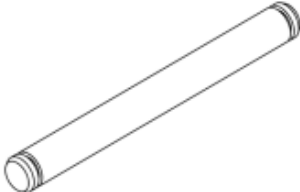

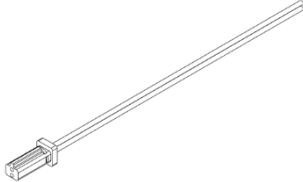
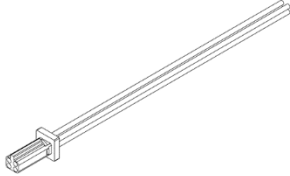
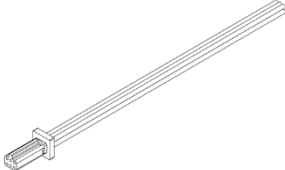

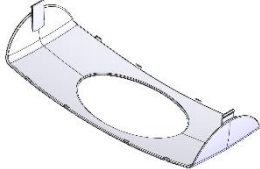
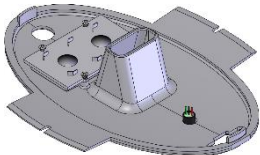

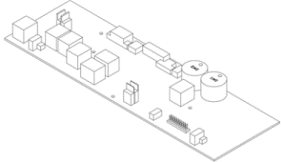
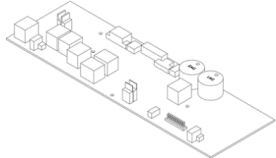
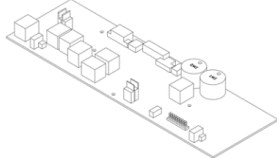
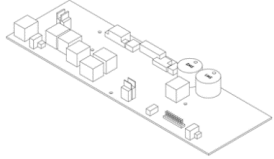

Please refer to the information in the table below for a complete list of spare parts available for the Transactive Extra Hoist. Please note that these details are subject to change.

Article No.	Part Illustration	Description – Part Code
1.		Lift Motor 800337
2.		Traverse Motor Assembly 800072

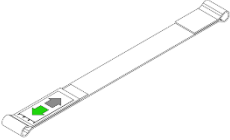
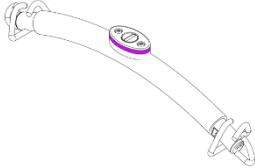
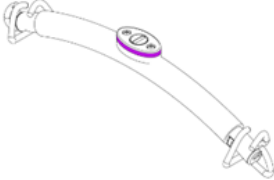
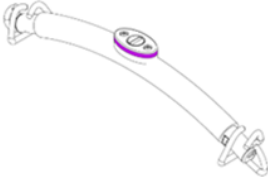
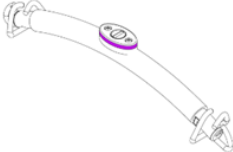
3.		<p>Battery (Single) 800083</p>
4.		<p>Hub Assembly 800050</p>
5.		<p>Bottom Plate Assembly 800056</p>
6.		<p>Emergency Lower Switch 800066</p>
7.		<p>Emergency Lower Cord 122011</p>
8.		<p>Strap Pin 800044</p>
9.		<p>Manual Lower 800225</p>
10.		<p>2 Way Grommet/ Air Tube Assembly 122018</p>
11.		<p>4 Way Grommet/ Air Tube Assembly 122019</p>
12.		<p>6Way Grommet/ Air Tube Assembly 122082</p>

13.		Bottom Cover (Outer) 800320
14.		Bottom Cover (w/LCD) 800322
15.		2 Way Pneumatic Handset (Manual) 800334
16.		4 Way Pneumatic Handset (Driven) 800335
17.		4 Way Pneumatic Handset (Manual) 800346
18.		6 Way Pneumatic Handset (Driven) 800336
19.		2 Way PCB 130 kg SWL 122078-130
20.		2 Way PCB 160 kg SWL 122078-160
21.		2 Way PCB 200 kg SWL 122078-200
22.		2 Way PCB 270 kg SWL 122078-270



23.		<p>4 Way PCB 130 kg SWL 122058-130</p>
24.		<p>4 Way PCB 160 kg SWL 122058-160</p>
25.		<p>4 Way PCB 200 kg SWL 122058-200</p>
26.		<p>4 Way PCB 270 kg SWL 122058-270</p>
27.		<p>6 Way PCB 130 kg SWL 122131-130</p>
28.		<p>6 Way PCB 160 kg SWL 122131-160</p>
29.		<p>6 Way PCB 200 kg SWL 122131-200</p>
30.		<p>6 Way PCB 270 kg SWL 122131-270</p>
31.		<p>Lift Tape - 130 kg SWL 440060</p>
32.		<p>Lift Tape - 160 kg SWL 440065</p>
33.		<p>Lift Tape - 200 kg SWL 440070</p>

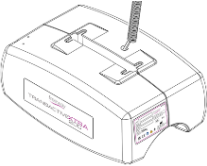
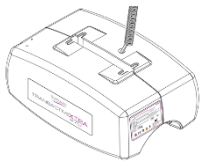
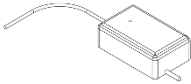
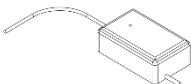
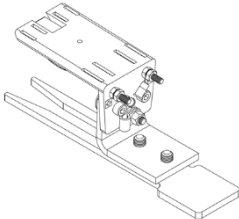
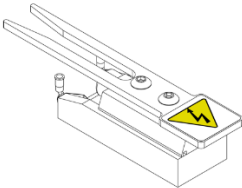
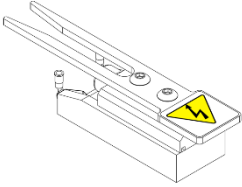
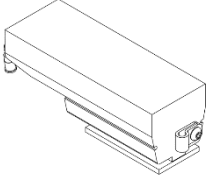
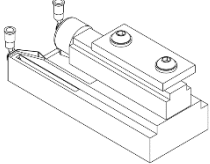
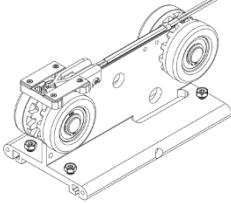

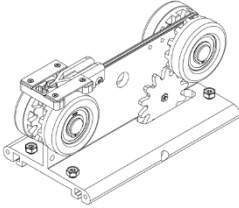
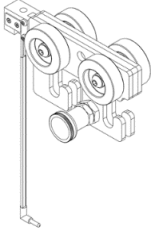
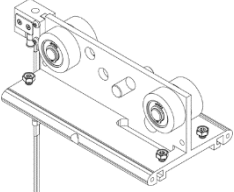
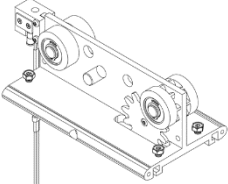
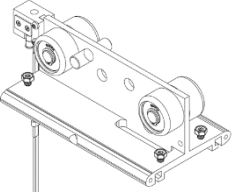
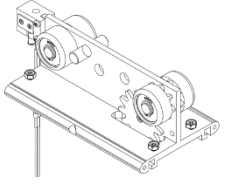
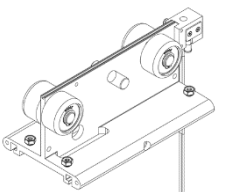
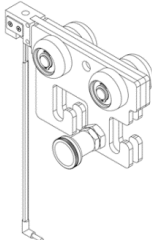
34.		Lift Tape - 270 kg SWL 440075
35.		Transactive Xtra Carry Bar 130 kg SWL 300903
36.		Transactive Xtra Carry Bar 160 kg SWL 300904
37.		Transactive Xtra Carry Bar 200 kg SWL 300905
38.		Transactive Xtra Carry Bar 270 kg SWL 300906
39.		Transactive Xtra Cover Set 130 kg SWL 134900
40.		Transactive Xtra Cover Set 160 kg SWL 134901
41.		Transactive Xtra Cover Set 200 kg SWL 134902
42.		Transactive Xtra Cover Set 270 kg SWL 134903
43.		Transactive Xtra Cover Set Powered "H" 130 kg SWL 134904
44.		Transactive Xtra Cover Set Powered "H" 160 kg SWL 134905

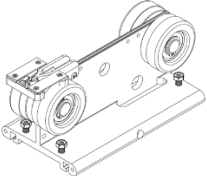
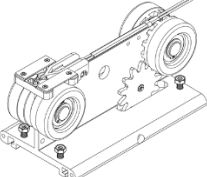
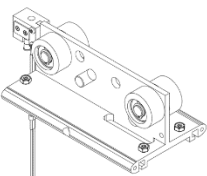
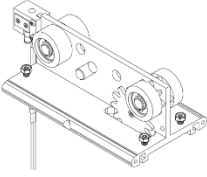
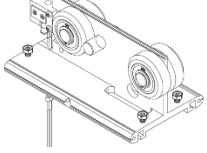
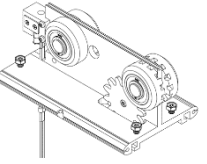
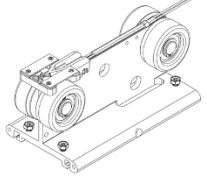
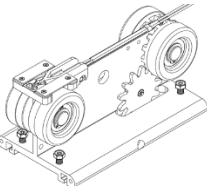
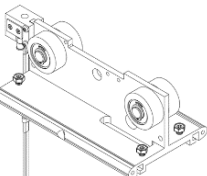
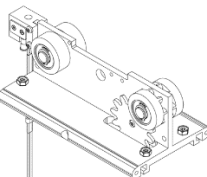
45.		<p>Transactive Xtra Cover Set Powered "H" 200 kg SWL 134906</p>
46.		<p>Transactive Xtra Cover Set Powered "H" 270 kg SWL 134907</p>
47.		<p>Spur Plug 600024</p>
48.		<p>Euro Plug 600030</p>
49.		<p>Charger Dock (Track Type 1/7) 122362</p>
50.		<p>Charger Dock (Track Type 2/12) 122365</p>
51.		<p>Charger Dock (Track Type 3/4/5/6) 122366</p>
52.		<p>Charger Dock (Track Type 8/10/11/13/14) 122367</p>
53.		<p>Charger Dock (Track Type 9) 122368</p>
54.		<p>Trolley Top (Manual) (Track Type 1) 600018</p>

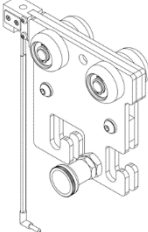
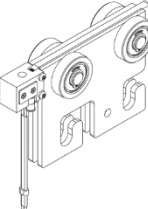
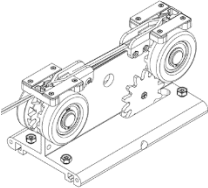
55.		<p>Trolley Top (Driven) (Track Type 1) 600002</p>
56.		<p>Trolley Top (QRT) (Track Type 1) 600075</p>
59.		<p>Trolley Top (Manual) (Track Type 2/13/14) 160016</p>
60.		<p>Trolley Top (Driven) (Track Type 2/13/14) 160015</p>
61.		<p>Trolley Top (Manual) (Track Type 3/4/6) 150009</p>
62.		<p>Trolley Top (Driven) (Track Type 3/4/6) 150019</p>
63.		<p>Trolley Top (Manual) (Track Type 5) 810001</p>
64.		<p>Trolley Top (QRT) (Track Type 5) 810010</p>

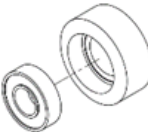
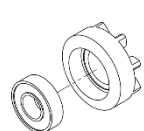
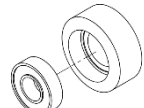
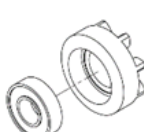
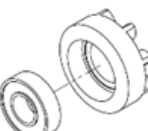
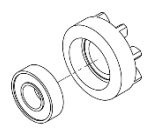
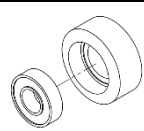
65.		<p>Trolley Top (Manual) (Track Type 7) 170001</p>
66.		<p>Trolley Top (Driven) (Track Type 7) 170006</p>
67.		<p>Trolley Top (Manual) (Track Type 8) 410006</p>
68.		<p>Trolley Top (Driven) (Track Type 8) 410004</p>
69.		<p>Trolley Top (Manual) (Track Type 9) 140024</p>
70.		<p>Trolley Top (Driven) (Track Type 9) 140005</p>
71.		<p>Trolley Top (Manual) (Track Type 10) 940002</p>
72.		<p>Trolley Top (Driven) (Track Type 10) 940005</p>
73.		<p>Trolley Top (Manual) (Track Type 11) 890004</p>
74.		<p>Trolley Top (Driven) (Track Type 11) 890003</p>

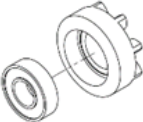
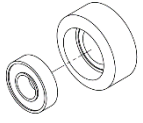
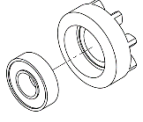
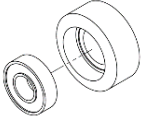
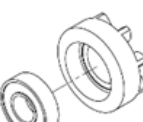
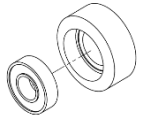
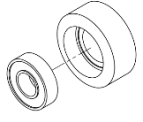
75.		<p>Trolley Top (QRT) (Track Type 12) 113001</p>
76.		<p>Trolley Top (QRT) (Track Type 13/14) 160024</p>
77.		<p>Trolley Top (Driven) (Powered Turntable) 600032</p>
78.		<p>Geared Wheel & Bearing (Track Type 1) 134908</p>
79.		<p>Ungearing Wheel & Bearing (2/11/13/14) 134909</p>
80.		<p>Geared Wheel & Bearing (2/11/13/14) 134910</p>
81.		<p>Ungearing Wheel & Bearing (3/4/5/6) 134911</p>
82.		<p>Geared Wheel & Bearing (3/4/5/6) 134912</p>
83.		<p>Ungearing Wheel & Bearing (Track Type 7) 134913</p>
84.		<p>Geared Wheel & Bearing (Track Type 7) 134914</p>
85.		<p>Ungearing Wheel & Bearing (Track Type 8) 134915</p>

86.		<p>Geared Wheel & Bearing (Track Type 8) 134916</p>
87.		<p>Ungeared Wheel & Bearing (Track Type 9) 134917</p>
88.		<p>Geared Wheel & Bearing (Track Type 9) 134918</p>
89.		<p>Ungeared Wheel & Bearing (Track Type 10) 134919</p>
90.		<p>Geared Wheel & Bearing (Track Type 10) 134920</p>
91.		<p>Wheel & Bearing (QRT Track Type 1) 134921</p>
92.		<p>Wheel & Bearing (QRT Track 5/12) 134922</p>
93.		<p>Wheel & Bearing (QRT Track 13/14) 134923</p>
94.		<p>Freeway Transactive Xtra User Manual 999075 (Rev C)</p>

Dealer/service contact details:

Manufacture contact details:

Prism Medical UK

Unit 1, Tir Llwyd Industrial Estate,
St Asaph Avenue, Kinmel Bay,
Conwy, United Kingdom, LL18 5JZ

Telephone Number: 01924 840100

Disclaimer

While every effort has been made to ensure the accuracy of information contained in this manual, no liability can be accepted by Prism Medical UK for any errors or omissions. Prism Medical UK operates a policy of continuous improvement. Specifications and other data are subject to change without notice.



freeway

Unit 1, Tir Llwyd Industrial Estate,
St Asaph Avenue, Kinmel Bay, LL18 5JZ

