

# Constant Charge End Caps Data Sheet

Single Track End Cap – Constant Charge (700220)

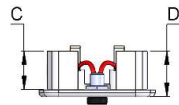

Mid-Duty Track End Cap – Constant Charge

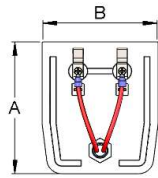
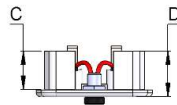
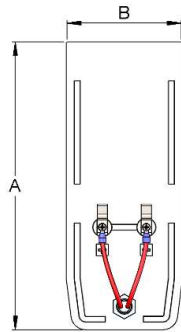

Heavy-Duty Track End Cap – Constant Charge

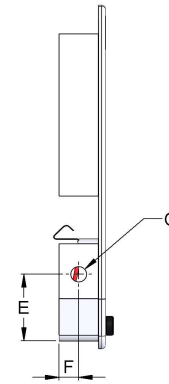
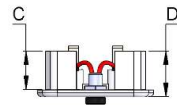
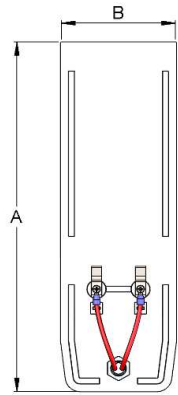

Constant Charge End Cap Dimensions (mm/inches)

Dimensions (Ref to drawing)	Single Track End Cap – Constant Charge	Mid-Duty Track End Cap – Constant Charge	Heavy-Duty Track End Cap – Constant Charge
A	68mm	148mm	180mm
B	57mm	57mm	57mm
C	19.8mm	19.8mm	19.8mm
D	23.5mm	23.5mm	23.5mm
E	35mm	35mm	35mm
F	10mm	10mm	10mm
G	ø6mm	ø6mm	ø6mm

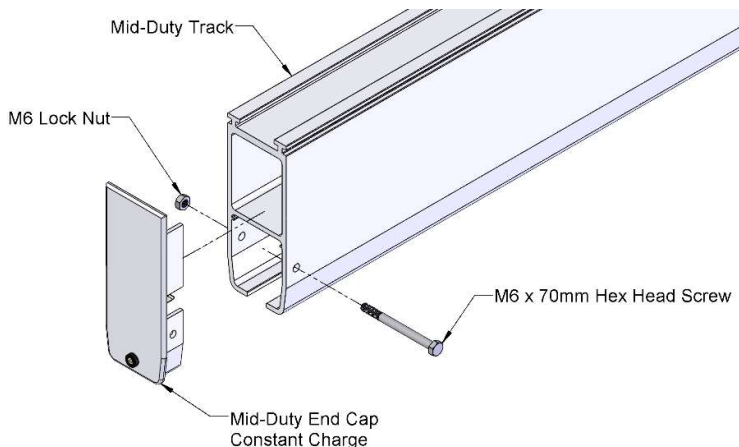

- Constant charge end caps are required to link the CC systems together.
- Only one constant charge end cap is required at the end of a system.
- Constant charge end caps are used to close the install creating a complete system.
- The constant charge end cap is used in combination with the safety bolt to secure in place.